

	<h1 style="margin: 0;">MXAP</h1> <p style="margin: 0;">デジタル設定形 アナログパルス変換器</p>	<h1 style="margin: 0;">MX·UNIT</h1>
外形図		

特記事項

外形寸法図 (単位: mm)

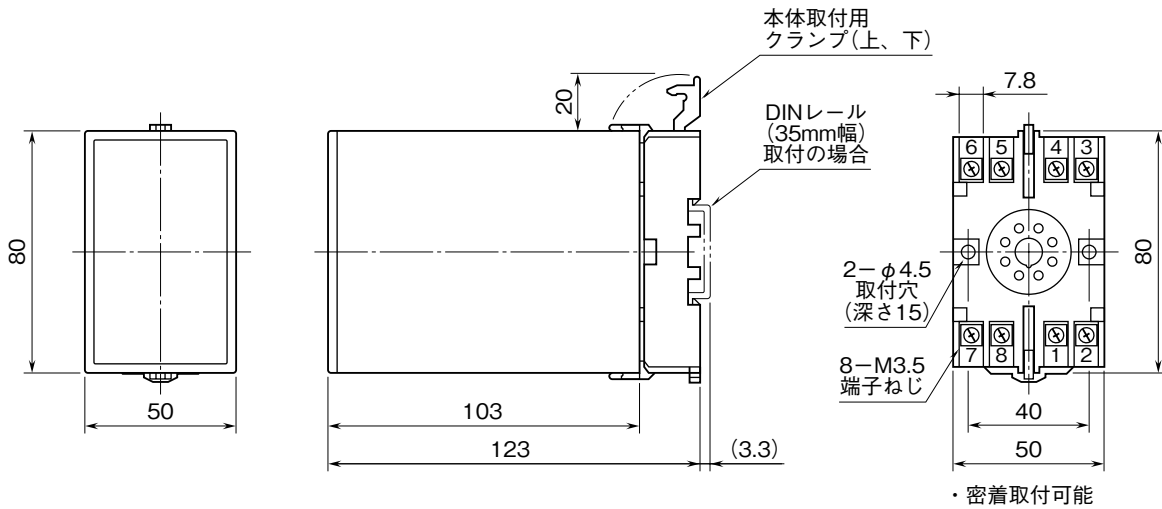

端子接続図

端子番号図 (単位: mm)

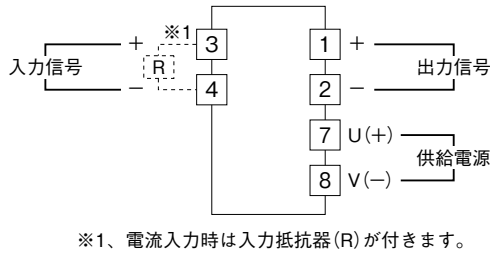

入力抵抗器 (REM)

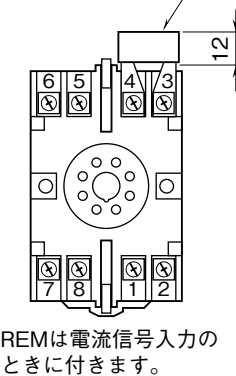

出力部接続例

■オープンコレクタ出力

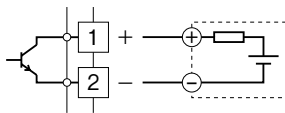

■RS-422ラインドライバ・パルス出力

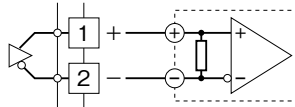

■電圧パルス出力

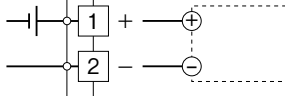

■無接点AC、DCスイッチ出力

・AC電源のとき

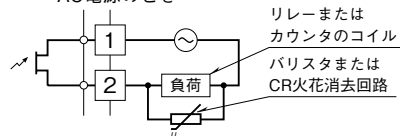

・DC電源のとき

