

## Remote I/O R8 Series

### NPN TRANSISTOR OUTPUT MODULE, 16 points

(with shortcircuit protection, full and partial interlock)

#### Functions & Features

- 16 channels for discrete output, compact size remote I/O module
- 20 pin MIL connector
- With interlock input it is available to turn all or half of outputs off.

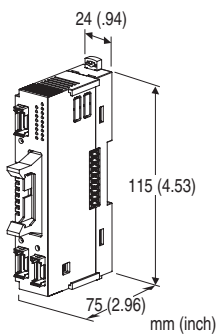

## MODEL: R8-DCM16ALH[1]

### ORDERING INFORMATION

- Code number: R8-DCM16ALH[1]  
Specify a code from below for [1].  
(e.g. R8-DCM16ALH/Q)
- Specify the specification for option code /Q  
(e.g. /C01)

### [1] OPTIONS

blank: none

/Q: With options (specify the specification)

### SPECIFICATIONS OF OPTION: Q

**COATING (For the detail, refer to M-System's web site.)**

/C01: Silicone coating

/C02: Polyurethane coating

### RELATED PRODUCTS

- PC configurator software (model: R8CFG)  
Downloadable at M-System's web site.  
A dedicated cable is required to connect the module to the PC. Please refer to the internet software download site or the users manual for the PC configurator for applicable cable types.  
Note: When using with Power/Network module (model: R8-NM1), firmware version Ver1.04 or later is supported.

### GENERAL SPECIFICATIONS

#### Connection

- **Input:** 4-pin e-CON connector  
PWB connector XN2D-1474-S002 (Omron)  
Recommended cable connector XN2A-1470 (Omron)  
Applicable wire size 0.08 mm<sup>2</sup> (AWG28) - 0.5 mm<sup>2</sup> (AWG20)  
Outer sheath diameter: max. 1.5 dia  
(The cable connector is not included in the package. Refer to the specifications of the product.)

- **Output:** 20-pin MIL connector  
PWB connector XG4A-2034 (Omron)  
Recommended socket XG5N-201 (Omron)  
Recommended contact XG5W-0231 (Omron)  
Applicable wire size AWG22, number of conductor 17, diameter of conductor 0.16 mm

(The socket and contact are not included in the package. Refer to the specifications of the product.)

- **Excitation supply, internal bus:** Connected to internal bus connector

- **Internal power:** Supplied from internal bus connector

**Isolation:** I/O or exc. supply to internal bus or internal power

**Module address:** DIP switches

**Terminating resistor:** Built-in (DIP Switch, default: disable)  
(The others switches depend on operating mode settings)

**Indicator LEDs:** Bi-color (red/green) LED; Refer to the instruction manual.

**Discrete output status indicators:** Green LED; Refer to the instruction manual.

**Interlock status indicators:** Red LED; Refer to the instruction manual.

### INTERLOCK INPUT SPECIFICATION

**Common:** Negative common (PNP)

**Number of input:** 3 point

**Rated input voltage:** 24 V DC  $\pm 10\%$ ; ripple 5 %p-p max.

**ON voltage / current:**  $\geq 15$  V DC (input - 0V) /  $\geq 2.3$  mA

**OFF voltage / current:**  $\leq 5$  V DC (input - 0V) /  $\leq 1$  mA

**Input current:**  $\leq 4.5$  mA per point at 24 V DC

**Input resistance:** Approx. 5.7 k $\Omega$

**ON delay:**  $\leq 2.0$  msec.

**OFF delay:**  $\leq 2.0$  msec.

The output turns to OFF during interlock is input.

### OUTPUT SPECIFICATIONS

**Common:** Negative common (NPN) per 16 points

**Maximum outputs applicable at once:** No limit (at 24 V DC)

**Number of output:** 16 points

**Rated load voltage:** 24 V DC  $\pm 10\%$

**Rated output current:** 0.1 A per point, 1.6 A per common

**Residual voltage:**  $\leq 0.5$  V

**Leakage current:**  $\leq 0.1$  mA

**ON delay:**  $\leq 0.5$  msec.

**OFF delay:**  $\leq 1.5$  msec.

With shortcircuit protection

With overheat protection

(When driving an inductive load, connect a diode in parallel with the load.)

## INSTALLATION

**Max. current consumption:** 160 mA

**Operating temperature:** -10 to +55°C (14 to 131°F)

**Operating humidity:** 30 to 90 %RH (non-condensing)

**Atmosphere:** No corrosive gas or heavy dust

**Mounting:** DIN rail

**Weight:** 110 g (0.24 lb)

## PERFORMANCE

**Data allocation:** 1

**Module addresses in use:** 1

**Power output (input connector):** Rated current 50 mA DC per channel

**Power output (output connector):** Rated current 3 A DC (rated current 3 A for internal fuse (slow blow fuse  $i^2t$  (A<sup>2</sup>sec) max. 5.04)

**Insulation resistance:**  $\geq 100$  MΩ with 500 V DC

**Dielectric strength:** 1500V AC @1 minute (I/O or exc. supply to internal bus or internal power to ground)

## STANDARDS & APPROVALS

**EU conformity:**

EMC Directive

EMI EN 61000-6-4

EMS EN 61000-6-2

RoHS Directive

EN 50581

## EXTERNAL VIEW

■ LEFT SIDE VIEW

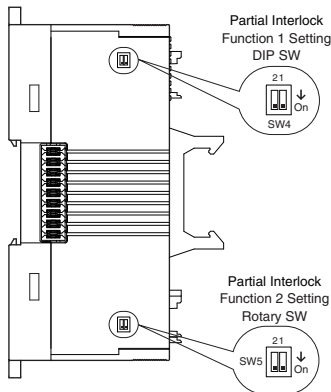

■ FRONT VIEW

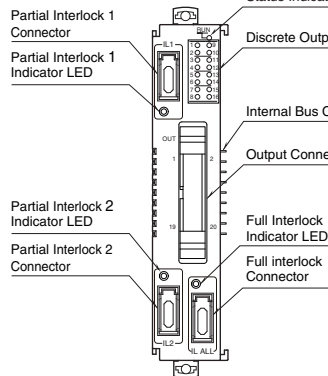

■ RIGHT SIDE VIEW

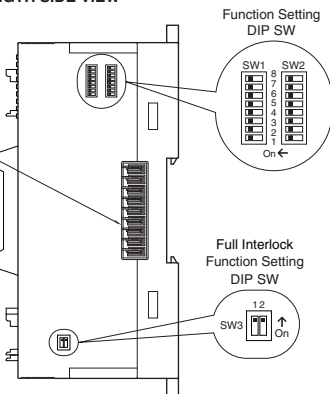

## OPERATING MODE SETTING

(\*) Factory setting

### ■ MODULE ADDRESS

Module address can be set with SW1-1 through 1-4 for the tens, and SW1-5 through 1-8 for the ones place digit.

Address is selected between 0 to 31. (Factory setting: 0)

MODULE ADDRESS	SW1			
	1 5	2 6	3 7	4 8
0	OFF	OFF	OFF	OFF
1	OFF	OFF	OFF	ON
2	OFF	OFF	ON	OFF
3	OFF	OFF	ON	ON
4	OFF	ON	OFF	OFF
5	OFF	ON	OFF	ON
6	OFF	ON	ON	OFF
7	OFF	ON	ON	ON
8	ON	OFF	OFF	OFF
9	ON	OFF	OFF	ON

### ■ INTERLOCK COMMUNICATION LOGIC REVERSAL

Setting internal communication bus logic.

Interlock Communication Logic Reversal	SW2-1
Interlock function setting off: 1 Interlock function setting on: normal = 1, interlock = 0	ON
Interlock function setting off: 0 (*) Interlock function setting on: normal = 0, interlock = 1	OFF

Caution: 1 and 0 values are validated as logic through internal communication bus logic.

### ■ OUTPUT AT THE LOSS OF COMMUNICATION

Setting for all output.

OUTPUT AT THE LOSS OF COMMUNICATION	SW2-5
Output Hold (*) (last data correctly received is hold)	OFF
Stop output (Output fixed at OFF)	ON

### ■ TERMINATOR DIP SW

TERMINATOR SW	SW2-6
Without (*)	OFF
With	ON

### ■ CONFIGURATION MODE

CONFIGURATION MODE	SW2-8
DIP switch setting (*)	OFF
PC	ON

Caution: SW2-2 through 2-4 and 2-7 are unused; be sure to turn OFF unused channels.

### ■ FULL INTERLOCK FUNCTION

It is available to apply full interlock function to all outputs (Do1 through Do16)

Full Interlock Function	SW3-1
OFF	OFF
ON (*) (all outputs OFF if input OFF)	ON

Caution: SW3-2 is unused; be sure to turn OFF unused channels.

### ■ PARTIAL INTERLOCK

#### • Partital interlock function 1

At output, it is available to apply interlock function to Do1 though Do8.

PARTIAL INTERLOCK 1	SW4 1
OFF	OFF
ON (*) (Input OFF with output OFF)	ON

#### • Partital interlock function 2

At output, it is available to apply interlock function to Do9 though Do16.

PARTIAL INTERLOCK 2	SW5 1
OFF	OFF
ON (*) (Input OFF with output OFF)	ON

Caution: SW4-2 and 5-2 are unused; be sure to turn OFF unused channels.

**DIMENSIONS unit: mm (inch)**

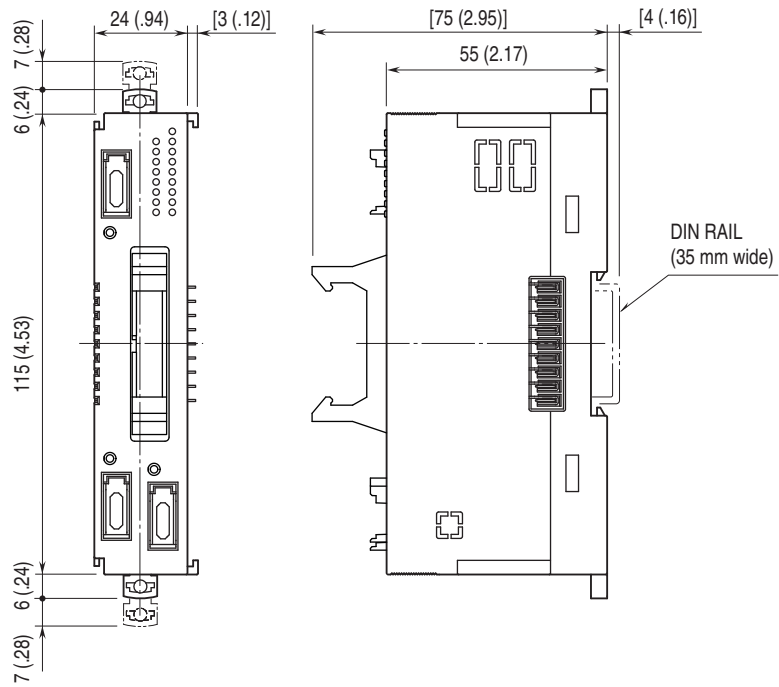

**SCHEMATIC CIRCUITRY & CONNECTION DIAGRAM**

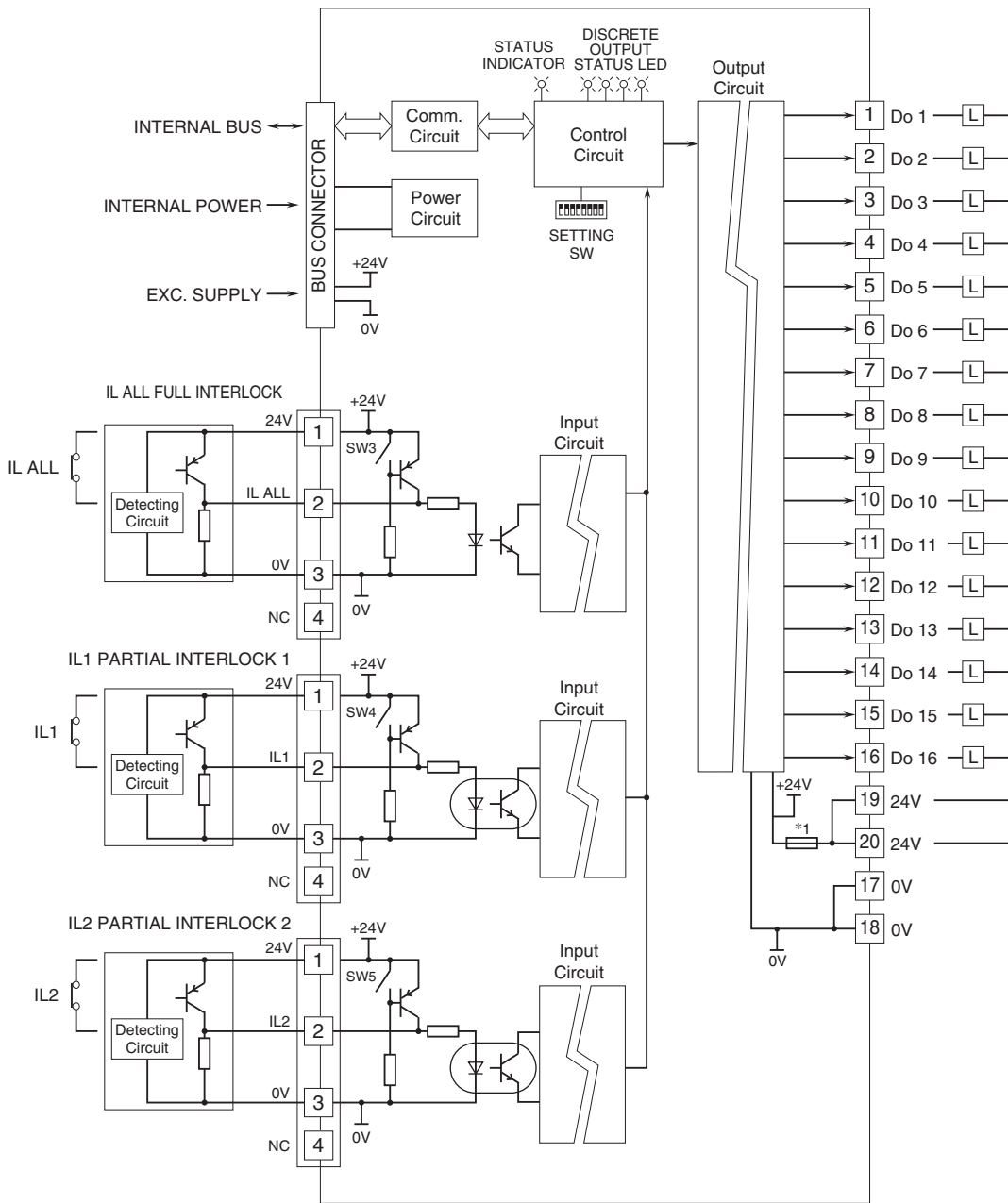

\*1. Fuse is not replazable.

## ■ OUTPUT CIRCUIT

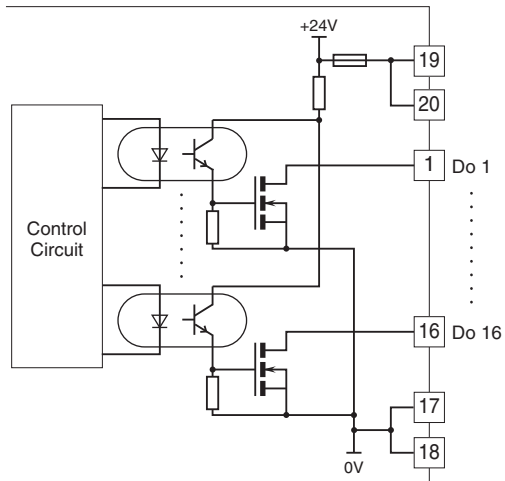

Specifications are subject to change without notice.