

Temperature Controller TC10 Series

TEMPERATURE CONTROLLER

(Modbus, 5 digit, LED display type, size 48 x 96 mm)

Functions & Features

- One PID controller
- Universal input x 1 point, control output x 4 points, discrete input x 2 points, clamp-on current sensor input x 1 point
- Universal input configurable to T/C, RTD, DC current or voltage independently
- Discrete inputs usable to switch PID bank or operation mode
- Control outputs configurable to MV, PV or alarm
- Clamp-on current sensor input enables to detect heater wire break or over current
- Auto tuning function

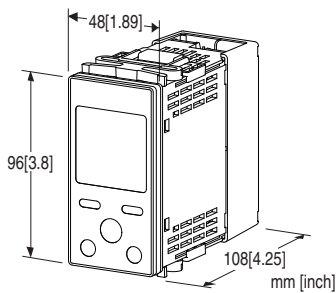

MODEL: TC10NM-[1]-M2

ORDERING INFORMATION

- Code number: TC10NM-[1]-M2
- Specify a code from below for [1].
(e.g. TC10NM-A-M2)

[1] CONTROL OUTPUT

- A:** 0 - 20 mA DC (Load resistance 500 Ω max.)
Open-collector 2 points
- V:** 0 - 10 V DC (Load resistance 2 kΩ max.)
Open-collector 2 points
- P:** 12 V pulse (Load resistance 600 Ω max.)
Open-collector 2 points

POWER INPUT

AC Power

M2: 100 - 240 V AC (Operational voltage range 85 - 264 V, 47 - 66 Hz)

RELATED PRODUCTS

- PC configurator software (model: TC10CFG)
Downloadable at M-System's web site.
- A dedicated cable is required to connect the module to the PC. Please refer to the internet software download site or the users manual for the PC configurator for applicable cable types.
- Clamp-on current sensor (model: CLSE)
(Used for detecting the heater wire break)

GENERAL SPECIFICATIONS

- Construction:** Panel flush mounting
- Degree of protection:** IP65; applicable to the front panel of the unit with single mounting according to the specified panel cutout
- Configuration jack:** 2.5 dia. miniature jack connector; RS-232-C level (bottom of the unit)
- Connection:** M3 separable screw terminal (torque 0.5 N·m)
- Solderless terminal:** Refer to the drawing at the end of the section.

Recommended manufacturer: Japan Solderless Terminal MFG.Co.Ltd, Nichifu Co.,Ltd

Applicable wire size: 0.25 to 1.65 mm² (AWG 22 to 16)

Screw terminal: Nickel-plated steel

Housing material: Flame-resistant resin (gray)

Isolation: Pv1 to CT1 to Di1 or Di2 to MV1 to MV2 to Do1 or Do2 to Modbus to power

CT Input waveform

RMS sensing: Up to 15 % of 3rd harmonic content

Control mode: Standard PID, heating and cooling control (ON/OFF, PID)

Proportional band (P): 0.1 to 3200.0 (temperature unit)

Integral time (I): 0 to 3999 sec.

Derivative time (D): 0.0 to 999.9 sec.

Auto-tuning: Limit cycle method

Alarm: Deviation high & low, absolute high & low, etc.

Sampling cycle: 100 msec.

Control cycle: 1.0 to 99.9 sec.

(100 msec. fixed for Mv output 0 - 20 mA DC and 0 - 10 V DC)

Mv output range: -5 - +105 % for output scale

Parameters: Stored in non-volatile memory; write/erase cycle endurance: less than 1 000 000

Parameter setting: With front panel operation buttons or PC configurator software (model: TC10CFG)

- Universal input
- Burnout on/off
- Control output
- Bank
- Event input
- CT input
- Auto-tuning

Refer to the instruction manual for detail.

■ Recommended solderless terminal

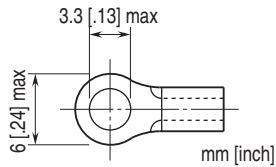

MODBUS COMMUNICATION

Communication: Half-duplex, asynchronous, no procedure

Standard: Conforms to TIA/EIA-485-A

Transmission distance: 500 meters max.

Transmission media: Shielded twisted-pair cable (CPEV-S 0.9 dia.)

Node address: 1 to 247

Data mode: RTU (Binary)

Parity: None, even or odd

Baud rate: 4800, 9600, 19.2 k, 38.4 k, 57.6 k (bps)

Stop bit: 1 or 2

Node address, parity, baud rate setting: With front panel operation buttons or PC configurator software (model: TC10CFG)

Terminating resistor: Built-in (Enable by shorting between pin 3 and 4)

DISPLAY

PV display: 5 digits 7-segment green LED, 10.2 mm (.40") height

SP display: 5 digits 7-segment red LED, 8.2 mm (.32") height, switchable to MV display

Display range: -32000 to 32000

Decimal point position: 10⁻¹ to 10⁻⁴ or none

Zero indication: Higher-digit zeros are suppressed.

Loop status indicators

Bank1: Green LED turns on when bank 1 chosen

Bank2: Green LED turns on when bank 2 chosen

Bank3: Green LED turns on when bank 3 chosen

Bank4: Green LED turns on when bank 4 chosen

Alarm1: Red LED turns on at alarm 1

Alarm2: Red LED turns on at alarm 2

Alarm3: Red LED turns on at alarm 3

Alarm4: Red LED turns on while setting is saving to the non-volatile memory.

Run: Green LED turns on while loop is in operation.

Man: Green LED turns on during manual mode

Local: Unused, off

At: Green LED turns on during auto-tuning

Out1: Green LED turns on when MV1 output

Out2: Green LED turns on when MV2 output

Engineering unit indication: Sticker label attached

DC, AC, mV, V, kV, μ A, mA, A, kA, mW, W, kW, var, kvar, Mvar, VA, Hz, Ω , k Ω , M Ω , cm, mm, m, m/sec, mm/min, cm/min, m/min, m/h, m/s², inch, l, l/s, l/min, l/h, m³, m³/sec, m³/min, m³/h, Nm³/h, N·m, N/m², g, kg, kg/h, N, kN, Pa, kPa, MPa, t, t/h, °C, °F, %RH, J, kJ, MJ, rpm, sec, min, min⁻¹, pH, %, ppm, etc.

INPUT SPECIFICATIONS

■ Universal input (Pv1)

For type and range configuration, refer to the instruction manual.

DC Current:

Input range: 0 - 20 mA DC

Input resistance: 49.9 Ω resistor incorporated

• DC voltage input

Input resistance: \geq 10 k Ω (-1000 to +1000 mV DC)

Input resistance: \geq 1 M Ω (-10 to +10 V DC)

• Thermocouple

Input resistance: \geq 10 k Ω

Input range: Refer to the table 1

Burnout sensing: \leq 4 μ A

Conformance range: Refer to the table 1

• RTD (2-wire or 3-wire)

Excitation: \leq 0.33 mA

Input range: Refer to the table 1

Allowable leadwire resistance: 20 Ω per wire

• Resistor (2-wire or 3-wire)

Excitation: \leq 0.33 mA

Input range: 0 - 4000 Ω

Allowable leadwire resistance: 20 Ω per wire

• Potentiometer

Excitation: \leq 0.33 mA

Input range: 0 to 4000 Ω

Allowable leadwire resistance: 20 Ω per wire

■ Clamp-on current sensor (CT1)

(Sensor model No.: AC input)

CLSE-R5: 0 - 5 A

CLSE-05: 0 - 50 A

CLSE-10: 0 - 100 A

CLSE-20: 0 - 200 A

CLSE-40: 0 - 400 A

CLSE-60: 0 - 600 A

Frequency: 50 / 60 Hz (45 - 65 Hz)

Max. working voltage: 480 V AC (primary side)

Overload capacity:

CLSE-R5: 10 A continuous, x40 (1 sec.)

CLSE-05: 60 A continuous, x40 (1 sec.)

CLSE-10: 120 A continuous, x40 (1 sec.)

CLSE-20: 240 A continuous, x40 (1 sec.)

CLSE-40: 480 A continuous, x40 (1 sec.)

CLSE-60: 720 A continuous, x40 (1 sec.)

Operational range

- CLSE-R5: ≤ 5 A
- CLSE-05: ≤ 50 A
- CLSE-10: ≤ 100 A
- CLSE-20: ≤ 200 A
- CLSE-40: ≤ 400 A
- CLSE-60: ≤ 600 A

Caution 1: The output values may vary depending on the accuracy of engagement at the clamp connection.

Caution 2: The sensor's mechanical construction may cause it to generate resonance sound. However, it does not affect the performance of the sensor.

■ Discrete Input (Di1, Di2)

Contact rating: 3.3 V @ 0.33 mA

Detection levels:

≤ 1.6 k Ω / 0.5 V at close

≥ 30 k Ω / 2.5 V at open

OUTPUT SPECIFICATIONS

Four control outputs are configurable to Mv, Ao or Do.

■ Control Output (Mv1, Mv2)

Specify one type of output with the code number from 3 types shown below.

- DC Current: 0 - 20 mA DC

Operational range: 0 - 23 mA DC

Load resistance: ≤ 500 Ω

- DC Voltage: 0 - 10 V DC

Operational range: 0 - 11.5 V DC

Load resistance: ≥ 2 k Ω

- 12 V Voltage pulse

Maximum frequency: 1 Hz

Minimum pulse width: 1 msec.

Hi level: 12 V ± 15 %

Lo level: ≤ 0.5 V

Load resistance: 600 Ω min.

■ Control Output (Do1, Do2)

- Open collector

Maximum frequency: 1 Hz

Minimum pulse width: 1 msec.

Output rating: 50 V DC 100 mA (resistive load)

Saturation voltage: 0.5 V DC

INSTALLATION

Power Consumption

•AC:

Approx. 6 VA at 100 V

Approx. 7 VA at 200 V

Approx. 8 VA at 240 V

Operating temperature: -10 to +55°C (14 to 131°F)

Operating humidity: 5 to 90 %RH (non-condensing)

Atmosphere: No corrosive gas or heavy dust

Mounting: Panel flush mounting

Weight: 300 g (0.66 lb)

PERFORMANCE in percentage of span

Accuracy

• **Pv1:** Refer to "Input type, range & conversion accuracy" section.

• **CT1:** ± 2 % (sensor error margin not included)

• **MV1 or MV2:** ± 0.5 % (added to the input accuracy)

Cold junction compensation error (thermocouple input):

± 2.0 °C at -10 - 55°C (± 3.6 °F at 14 - 131°F)

CJC sensor is adjacently attached to the input terminals.

Temp. coefficient

• **Pv1:** ± 0.03 %/°C (± 0.02 %/°F)

• **CT1:** ± 0.03 %/°C (± 0.02 %/°F)

Response time

• **CT1:** ≤ 2 sec. (0 - 90 %)

• **Mv1 or Mv2:** ≤ 1 sec. (0 - 90 %, DC output)

Burnout response (thermocouple, RTD, resistor,

potentiometer input): ≤ 10 s

Insulation resistance: ≥ 100 M Ω with 500 V DC

Dielectric strength: 2000 V AC @1 minute (Pv1 to CT1 to Di1 or Di2 to MV1 to MV2 to Do1 or Do2 to Modbus to power to ground)

STANDARDS & APPROVALS

EU conformity:

EMC Directive

EMI EN 61000-6-4

EMS EN 61000-6-2

Low Voltage Directive

EN 61010-1

Installation Category II

Pollution Degree 2

Input or output or Modbus to power - Reinforced insulation (300 V)

Input to output to Modbus - Basic insulation (300 V)

RoHS Directive

INPUT TYPE, RANGE & CONVERSION ACCURACY

INPUT TYPE		INPUT RANGE		ACCURACY		
DC CURRENT		0 to 20mA DC		±20µA		
DC VOLTAGE		-1000 to +1000mV DC		When max. range*2 is ≥60mV ±20µV		
		-10 to +10V DC		When max. range*2 is ≤120mV ±30µV When max. range*2 is ≥120mV ±200µV		
POTENTIOMETER		Total resistance up to 4000Ω*3		±0.1Ω or ±0.1%, whichever is greater		
RESISTOR		0 to 4000Ω		±0.1Ω or ±0.1%, whichever is greater		
Thermocouple	°C			°F		
	INPUT RANGE	ACCURACY *1	CONFORMANCE RANGE	INPUT RANGE	ACCURACY *1	CONFORMANCE RANGE
(PR)	0 to 1760	±1.80	0 to 1760	32 to 3200	±3.24	32 to 3200
K (CA)	-270 to +1370	±0.40	-150 to +1370	-454 to +2498	±0.72	-238 to +2498
E (CRC)	-270 to +1000	±0.60	-170 to +1000	-454 to +1832	±1.08	-274 to +1832
J (IC)	-210 to +1200	±0.70	-180 to +1200	-346 to +2192	±1.26	-292 to +2192
T (CC)	-270 to +400	±0.50	-170 to +400	-454 to +752	±0.90	-274 to +752
B (RH)	100 to 1820	±2.00	400 to 1760	212 to 3308	±3.60	752 to 3200
R	-50 to +1760	±1.00	200 to 1760	-58 to +3200	±1.80	392 to 3200
S	-50 to +1760	±1.00	0 to 1760	-58 to +3200	±1.80	32 to 3200
C (WRe 5-26)	0 to 2315	±1.00	0 to 2315	32 to 4199	±1.80	32 to 4199
N	-270 to +1300	±0.50	-130 to +1300	-454 to +2372	±0.90	-202 to +2372
U	-200 to +600	±0.50	-200 to +600	-328 to +1112	±0.90	-328 to +1112
L	-200 to +900	±0.30	-200 to +900	-328 to +1652	±0.54	-328 to +1652
P (Platinel II)	0 to 1395	±0.30	0 to 1395	32 to 2543	±0.54	32 to 2543
RTD	°C			°F		
	INPUT RANGE	ACCURACY		INPUT RANGE	ACCURACY	
Pt 100 (JIS '97, IEC)	-200 to +850	±0.40		-328 to +1562	±0.72	
Pt 500	-200 to +850	±0.40		-328 to +1562	±0.72	
Pt 1000	-200 to +850	±0.40		-328 to +1562	±0.72	
Pt 50Ω (JIS'81)	-200 to +649	±0.60		-328 to +1200	±1.08	
JPt 100 (JIS'89)	-200 to +510	±0.40		-328 to +950	±0.72	
Ni 508.4Ω	-50 to +200	±0.60		-58 to +392	±1.08	
Cu 10 (25°C)	-50 to +250	±2.00		-58 to +482	±3.60	

*1. Thermocouple: Add 2.0°C of cold-junction-compensation error.

*2. Max. range: absolute range (greater of 0% and 100% range values), whichever is greater.

*3. Refer to the operating manual for details.

EXTERNAL VIEW

FRONT VIEW

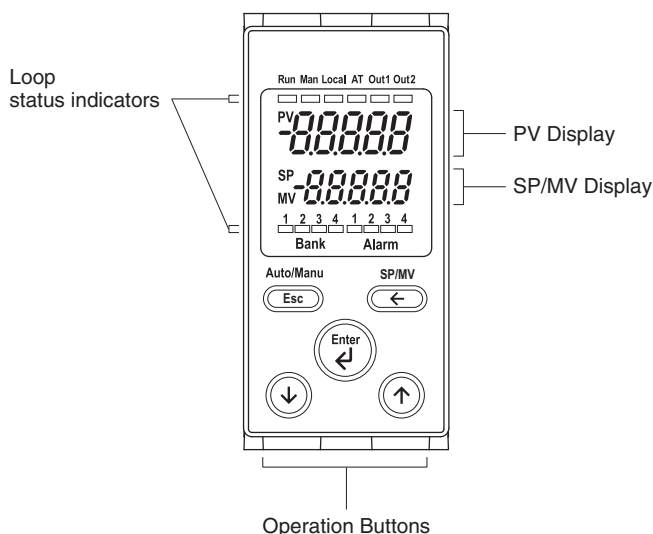

BOTTOM VIEW

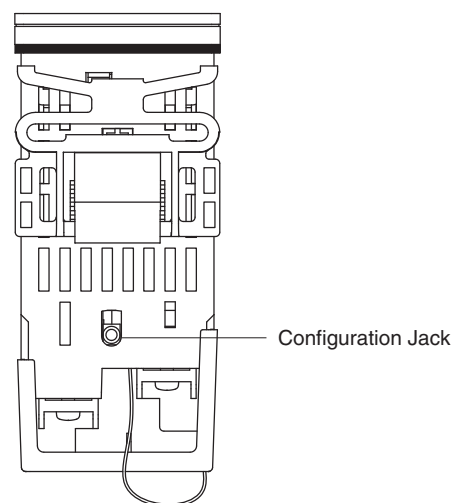

COMMUNICATION CABLE CONNECTIONS

■ MASTER CONNECTION

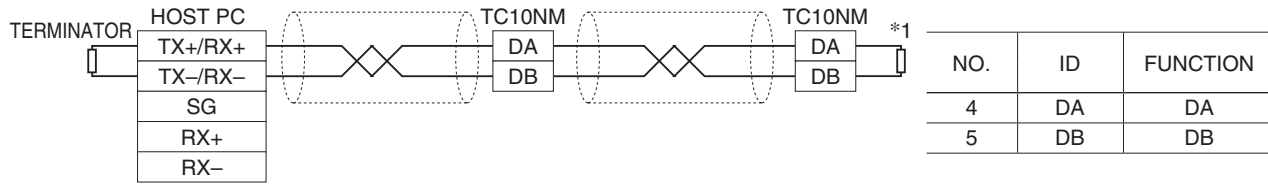

*1. For using internal terminator, short-across terminals 3 and 4.

EXTERNAL DIMENSIONS & TERMINAL ASSIGNMENTS unit: mm [inch]

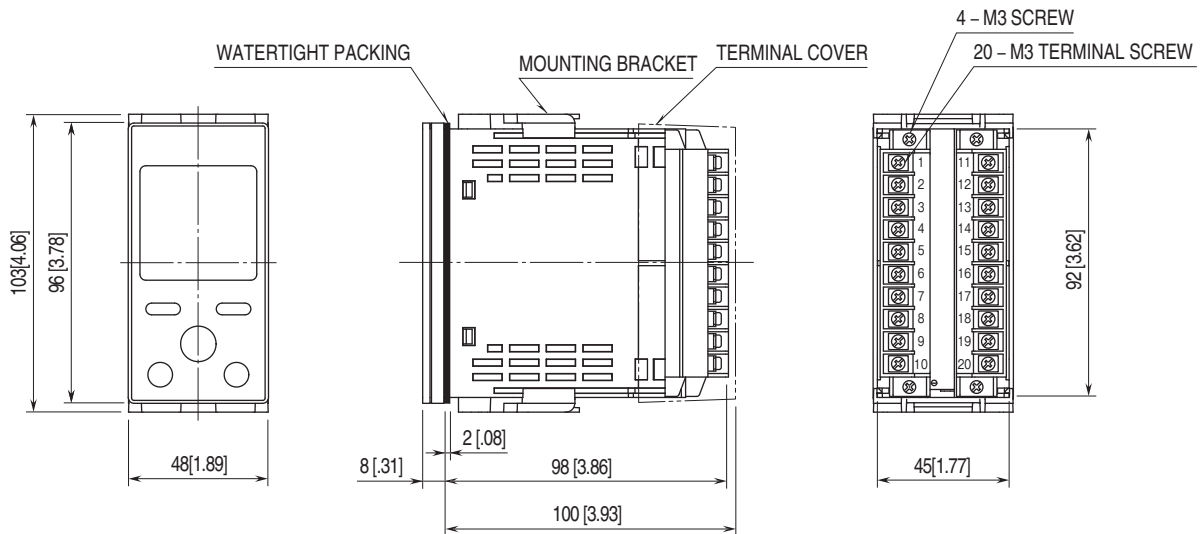

■ PANEL CUTOUT unit: mm (inch)

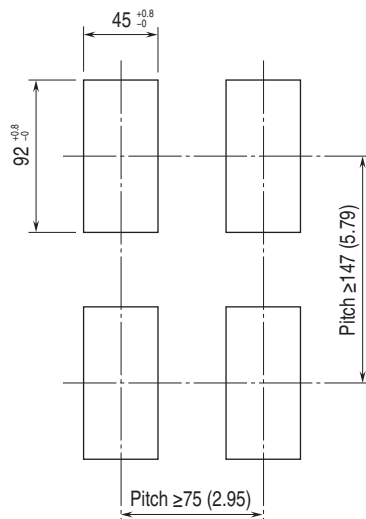

Mounting bracket: 0.5 - 10 (0.02 to 0.39)

SCHEMATIC CIRCUITRY & CONNECTION DIAGRAM

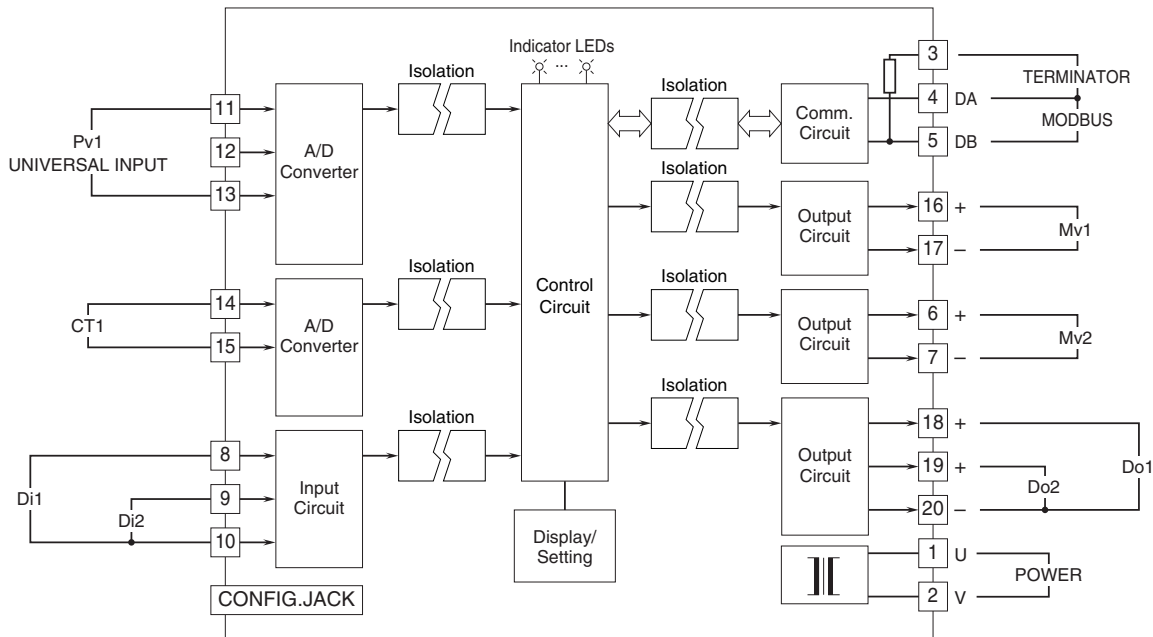

■ UNIVERSAL INPUT CONNECTION (Pv1) e.g.

- DC Current (0 – 20mA DC)
- DC Voltage (-1000 – +1000mV DC)
- DC Voltage (-10 – +10V DC)

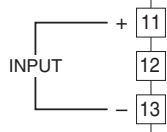

• Thermocouple

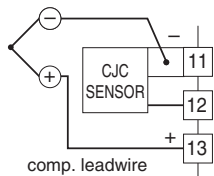

• RTD/Resistor (3-wire)

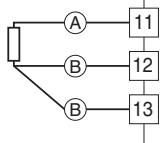

• RTD/Resistor (2-wire)

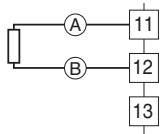

• Potentiometer

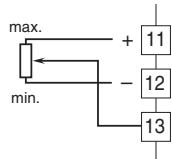

■ CT1 CONNECTION e.g.

- Clamp-on Current Sensor (model : CLSE)

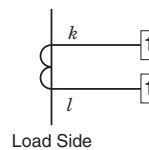

■ DISCRETE INPUT CONNECTION e.g.

- Mechanical Contact

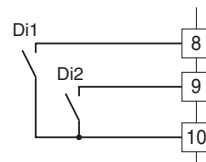

• Open Collector

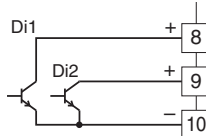

■ CONTROL OUTPUT 1 CONNECTION e.g.

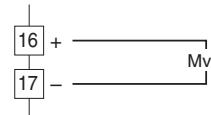

■ CONTROL OUTPUT 2 CONNECTION e.g.

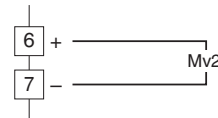

■ CONTROL OUTPUT 3 & 4 CONNECTION e.g.

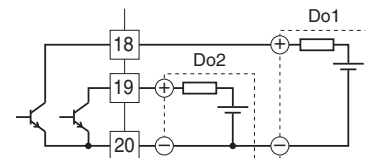



Specifications are subject to change without notice.