

Euro Terminal Ultra-Slim Signal Conditioners M6D Series

with the DIP switches.

DC/FREQUENCY CONVERTER

(PC programmable)

Function & features

- Converts a DC input into a FM (frequency modulation) or PWM (pulse width modulated) signal
- 5.9-mm wide ultra-slim design
- Low profile allows the M6D module mounted in a 120-mm deep panel
- PC programmable
- High-density mounting
- Power and status indicator LEDs

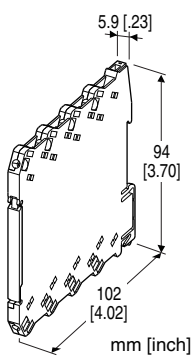

MODEL: M6DXAP-[1][2]-R[3]

ORDERING INFORMATION

- Code number: M6DXAP-[1][2]-R[3]
Specify a code from below for each of [1] through [3].
(e.g. M6DXAP-Z1A-R/Q)
- Specify the specification for option code /Q
(e.g. /C01/SET)

[1] INPUT

Current

Z1: Range 0 – 50 mA DC (Input resistance 25 Ω)

Voltage

S1: Range -1000 – +1000 mV DC (Input resistance 1 MΩ min.)

S2: Range -10 – +10 V DC (Input resistance 1 MΩ min.)

(Configurator software is used to change the input type and precise range.)

[2] OUTPUT

A: Open collector (100 kHz for FM, 1 kHz for PWM)

M: 5 V pulse (100 kHz for FM, 1 kHz for PWM)

N: 12 V pulse (100 kHz for FM, 1 kHz for PWM)

P: 24 V pulse (100 kHz for FM, 1 kHz for PWM)

Output modulation type and range are configurable with the configure software. The output signal type is configurable

POWER INPUT

DC Power

R: 24 V DC

(Operational voltage range 24 V ±10 %, ripple 10 %p-p max.)

[3] OPTIONS

blank: none

/Q: With options (specify the specification)

SPECIFICATIONS OF OPTION: Q (multiple selections)

COATING (For the detail, refer to M-System's web site.)

/C01: Silicone coating

/C02: Polyurethane coating

EX-FACTORY SETTING

/SET: Preset according to the Ordering Information Sheet
(No. ESU-7837)

RELATED PRODUCTS

- PC configurator software (model: M6CFG)

Downloadable at M-System's web site.

A dedicated cable is required to connect the module to the PC. Please refer to the internet software download site or the users manual for the PC configurator for applicable cable types.

GENERAL SPECIFICATIONS

Connection

Input and output: Euro terminal (torque 0.3 N·m)

Power input: Via the Installation Base (model: M6DBS)
or Euro terminal (torque 0.3 N·m)

Applicable wire size: 0.2 to 2.5 mm², stripped length 8 mm

Housing material: Flame-resistant resin (black)

Isolation: Input to output to power

Zero adjustment: -2 to +2 % (PC programming)

Span adjustment: 98 to 102 % (PC programming)

Power indicator LED: Green LED turns on when the power is supplied.

Status indicator LED: Orange LED; Blinking patterns indicate different operating status of the transmitter.

Programming: Downloaded from PC

- Input type and range
- Modulation type (FM, PWM)
- Output range
- Zero and span
- User's linearization table (max. 101 points, specified within -2 to +102 %)
- Others

(Refer to the instruction manual for details)

Configurator connection: 2.5 dia. miniature jack;
RS-232-C level

INPUT SPECIFICATIONS

■ **DC Current:** Input resistor incorporated
(If not specified, the input range is 4 – 20 mA DC.)

Input range: 0 – 50 mA DC

Minimum span: 2 mA

Offset: Lower range can be any specific value within the input range provided that the minimum span is maintained.

■ **DC Voltage**

• **Code S1 (narrow spans)**

Input range: -1000 – +1000 mV DC

Minimum span: 100 mV

• **Code S2 (wide spans)**

Input range: -10 – +10 V DC

Minimum span: 1 V

Offset: Lower range can be any specific value within the input range provided that the minimum span is maintained.

If not specified, the input range is shown below.

S1: 0 – 100 mV DC

S2: 1 – 5 V DC

OUTPUT SPECIFICATIONS

■ **Modulation**

• **Frequency modulation**

Output range: 0 to 100 %

Max. frequency: 100 kHz

Min. span: 0.01 Hz

(The output frequency changes according to the input signal. Duty rate is approx. 50 %)

• **Pulse width modulation**

Output range: 1 to 99 %

Usable frequency: 0.008 Hz to 1 kHz

(According to the input signal, the output pulse width (duty rate) changes without change of its frequency. The frequency is configurable with PC Configurator software, M6CFG.).

■ **Open Collector**

50 V DC @ 100 mA (resistive load)

Maximum frequency: 100 kHz

Saturation voltage: 0.5 V DC

(Factory default: 0 to 10 kHz, frequency modulation)

■ **Voltage Pulse**

High level: Rating (5, 12 or 24 V) ±10 %

Low level: ≤ 0.5 V

Load resistance:

- ≥ 1.0 kΩ for 5 V
- ≥ 2.4 kΩ for 12 V
- ≥ 4.8 kΩ for 24 V

Factory default: 0 to 10 kHz, Frequency modulation

INSTALLATION

Power consumption: Approx. 1 W

Operating temperature: -20 to +55°C (-4 to +131°F)

Operating humidity: 30 to 90 %RH (non-condensing)

Mounting: Installation Base (model: M6DBS) or DIN rail

Weight: 65 g (2.3 oz)

PERFORMANCE in percentage of span

Accuracy: Input accuracy + output accuracy

Inversely proportional to the span.

Input accuracy in percentage of input span:

• ±0.01 % for -1000 to +1000 mV

• ±0.01 % for -10 to +10 V

• ±0.02 % for 0 to 50 mA

Output accuracy at max. frequency (FM):

• ±0.10 % for ≤ 10 kHz

• ±0.05 % for ≤ 5 kHz

• ±0.02 % for ≤ 1 kHz

• For 10 kHz to 100 kHz output accuracy is following.

Output accuracy (%) = Max. frequency (kHz) x 0.01

Output accuracy (PWM): ±0.2 %

See CALCULATION EXAMPLES OF OVERALL ACCURACY.

Temp. coefficient: ±0.01 %/°C (±0.006 %/°F) of max. input span

Response time: 0.1 sec. + 1 pulse cycle of 100 % output

The time between the moment when the input changes 0 % to 100 % and the moment when the first pulse changes.

Line voltage effect: ±0.1 % over voltage range

Insulation resistance: ≥ 100 MΩ with 500 V DC

Dielectric strength: 2000 V AC @1 minute (input to output to power to ground)

CALCULATION EXAMPLES OF OVERALL ACCURACY

1. Frequency modulation

E.g.: Input range -10 to +10 V, input span 1 to 5 V, max. frequency 10 kHz

Input accuracy = Input range (20 V) ÷ Input span (4 V) x

Input accuracy (0.01 %) = 0.05 %

Output accuracy = 0.10 %

Overall accuracy = ±0.15 %

2. Pulse width modulation

E.g.: Input range -10 to +10 V, input span 1 to 5 V, frequency 1 kHz

Input accuracy = 0.05 % (same as above)

Output accuracy = 0.20 %

Overall accuracy = ±0.25 %

STANDARDS & APPROVALS

EU conformity:

EMC Directive

EMI EN 61000-6-4

EMS EN 61000-6-2
RoHS Directive

EXTERNAL VIEW

FRONT VIEW (with the cover open)

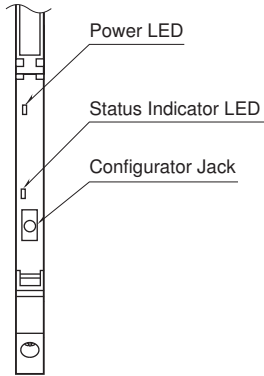

SIDE VIEW

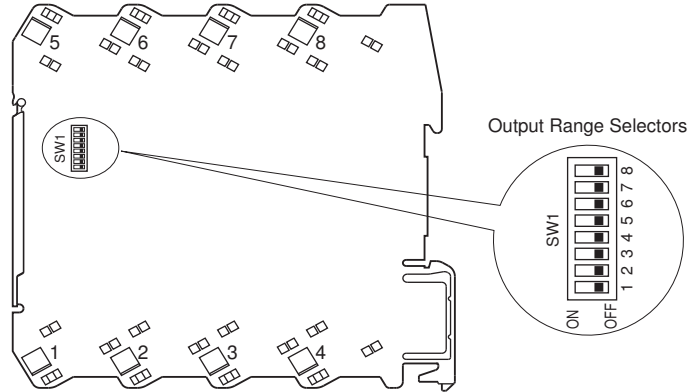

The output signal type is configurable with the DIP switches. Refer to the installation manual for detailed procedure.

EXTERNAL DIMENSIONS & TERMINAL ASSIGNMENTS unit: mm [inch]

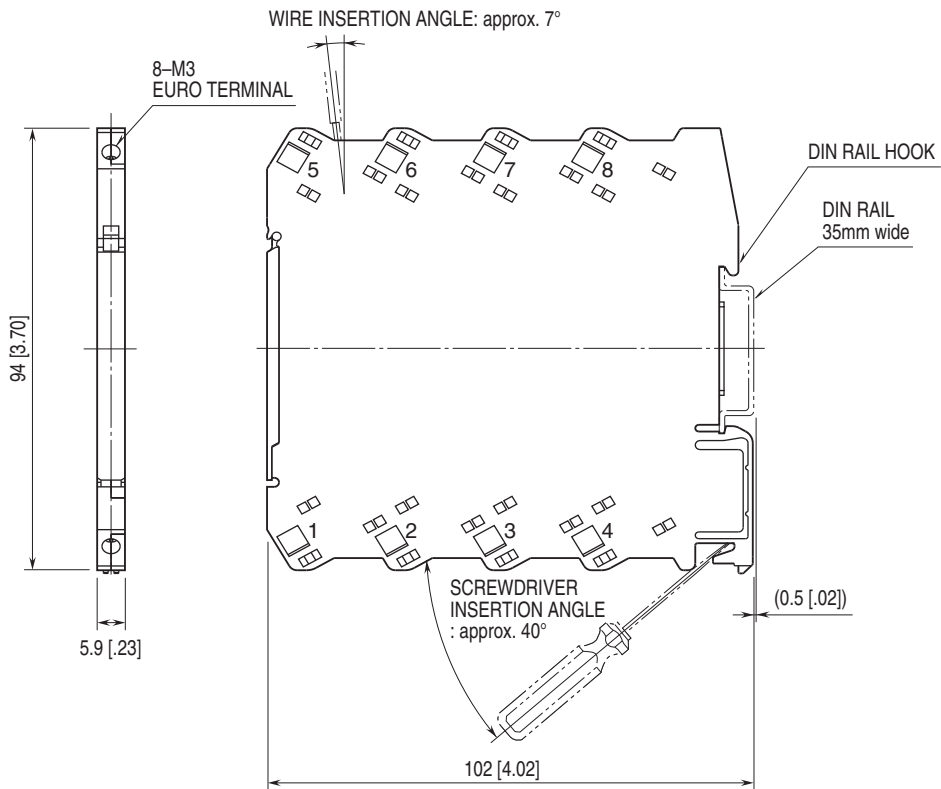

• When mounting, no extra space is needed between units.

SCHEMATIC CIRCUITRY & CONNECTION DIAGRAM

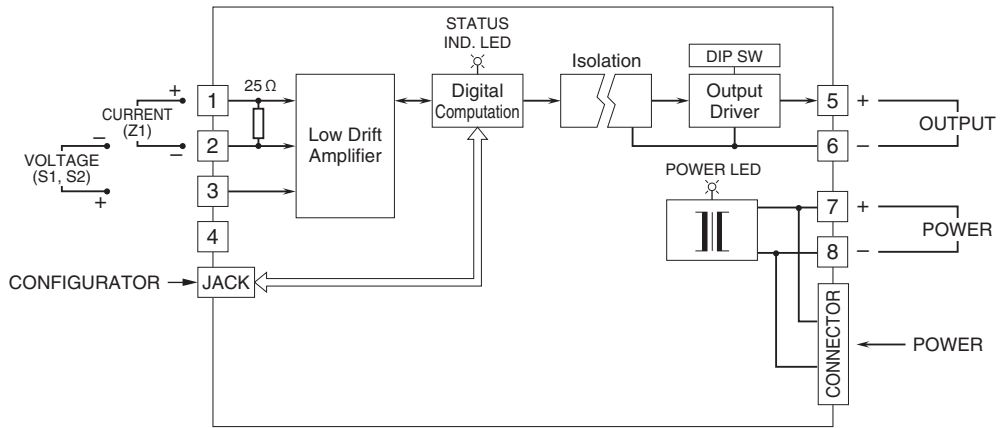

Output Connection Examples

■ Open Collector

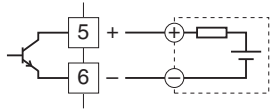

■ Voltage Pulse

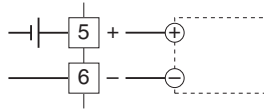

Specifications are subject to change without notice.