

## Plug-in Signal Conditioners M-UNIT

### PULSE ADDER

(field-programmable)

#### Functions & Features

- Adds two pulse inputs (counts number of pulses) and converts the pulse rate into convenient engineering unit for display on a totalizing counter or meter
- Various outputs (open collector, voltage pulse, noncontact AC/DC switch, RS-422 line driver pulse)
- Scaling factor is user-programmable by simply setting input and output frequencies via handheld programmer PU-2x
- Output frequency limiter ensures minimum pulse width

#### Typical Applications

- Positive displacement flowmeters or turbine flowmeters
- Adding flow pulse signals from blender

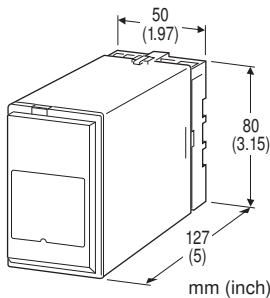

## MODEL: JPS3-[1][2][3][4]-[5][6]

### ORDERING INFORMATION

- Code number: JPS3-[1][2][3][4]-[5][6]
- Specify a code from below for each of [1] through [6].  
(e.g. JPS3-AP1N-K/Q)
- Use Ordering Information Sheet (No. ESU-1575). Default setting will be used if not otherwise specified.
- Factory default setting**
- Noise filter: None  
 Input pulse set count: 1  
 Output pulse set count: 1  
 Sampling time: 0.1 sec.  
 Max. output frequency: 10 Hz  
 One shot output: 50 msec.
- Specify the specification for option code /Q  
(e.g. /C01/S01)

### [1] INPUT 1 & 2

- A:** Open collector
- A2:** Mechanical contact

- B:** Voltage pulse (Specify sensitivity)
- H:** Two-wire current pulse (Specify sensitivity)

### [2] OUTPUT

- A:** Open collector (max. 100 kHz)
- M:** 5 V pulse (max. 100 kHz)
- N:** 12 V pulse (max. 100 kHz)
- P:** 24 V pulse (max. 100 kHz)
- J:** RS-422 line driver pulse (max. 100 kHz)
- R:** Noncontact AC/DC switch (max. 20 Hz)
- ( ) = Max. frequency

### [3] OUTPUT PULSE WIDTH

- 1:** No conversion to one-shot
- 3:** One-shot output (std. pulse width 50 msec.)  
(Specify when optional pulse width is required.)

### [4] OUTPUT LOGIC (both Input 1 & 2)

- N:** The same as the input
- R:** Inverted

### [5] POWER INPUT

- AC Power**
- K:** 85 - 132 V AC
- DC Power**
- S:** 12 V DC
- R:** 24 V DC
- V:** 48 V DC
- P:** 110 V DC

### [6] OPTIONS

- blank:** none
- /Q:** With options (specify the specification)

### SPECIFICATIONS OF OPTION: Q (multiple selections)

#### COATING (For the detail, refer to M-System's web site.)

- /C01:** Silicone coating
- /C02:** Polyurethane coating
- /C03:** Rubber coating

#### TERMINAL SCREW MATERIAL

- /S01:** Stainless steel

### CAUTION

This unit is not designed to output uniform pulses even when the input wave is uniform. It is not applicable to certain types of application.

## RELATED PRODUCTS

- Programming Unit (model: PU-2x)
- PC configurator software (model: JXCON)

Downloadable at M-System's web site.

A dedicated cable is required to connect the module to the PC. Please refer to the internet software download site or the users manual for the PC configurator for applicable cable types.

## GENERAL SPECIFICATIONS

**Construction:** Plug-in

**Connection:** M3.5 screw terminals

**Screw terminal:** Chromated steel (standard) or stainless steel

**Housing material:** Flame-resistant resin (black)

**Isolation:** Input 1 or input 2 to output to power

**Input monitor LED:** Red LED blinks according to the input.

**Output monitor:** Red LED blinks according to the output.

**Software programming:** Programming Unit (model: PU-2x); (Refer to the users manual of JXCON for the adjustments configurable with JXCON)

- Input and output pulse set count (frequency)
- Sampling time
- Others

**Adjustments:** With DIP switches.

- Noise filter

(Refer to the instruction manual for details)

**Sampling time:** 0.01 - 100 sec.

**Buffer counter capacity:** 4 294 967 295 counts (reset to 0 when the power is lost)

**Input pulse sensing:** DC coupled

## INPUT SPECIFICATIONS

**Max. frequency:** 100 kHz

(10 Hz for mechanical contact input)

**Minimum pulse width time requirement:** 5  $\mu$ sec.; 50 msec. for mechanical contact (for both ON and OFF)

### ■ Open Collector & Mechanical Contact

**Sensing voltage/current:** 12 V DC @ 2.3 mA

**Detecting level:** 2 V

(Detecting voltage in the internal circuit.)

**Detecting pulse state:** ON (input monitor LED OFF) and OFF (LED ON) detected

### ■ Voltage Pulse

Specify DC offset and pulse amplitude when ordering.

**Waveform:** Square or sine

**Input impedance:** 10 k $\Omega$  minimum

**Pulse amplitude:** 0.1 - 100 Vp-p (square)

1 - 100 Vp-p (sine or similar)

**Max. voltage between input terminals:** 50 V

**Detecting pulse state:** Pulse rise detected when the input

voltage goes above the detecting level (input monitor LED ON); pulse sink detected when it goes below the level (LED OFF).

### ■ Two-wire Current Pulse

Specify DC offset and pulse amplitude when ordering.

**Input resistance:** Receiving resistor 100  $\Omega$

**Input range:** 0 - 25 mA

**Minimum pulse amplitude:** 10 mA

**Detecting level:** 0 - 5 V

**Detecting pulse state:** The input resistor (100  $\Omega$ ) converts the current signal into 0 - 2.5 V. Pulse rise detected when the voltage goes above the detecting level (input monitor LED ON); pulse sink detected when it goes below the level (LED OFF).

### ■ Voltage pulse waveform

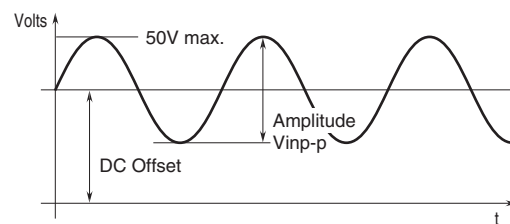

## OUTPUT SPECIFICATIONS

**Output pulse:** [No. of input pulse 1 + 2]  $\times$  scaling factor (scaling factor = output pulse set count / input pulse set count)

**Scalable range:** 1/1 000 000 to 1 000 000

■ **Open Collector:** 50 V DC @ 50 mA (resistive load)

**Saturation voltage:** 0.6 V DC

**Maximum frequency:** 100 kHz

### ■ Voltage Pulse

**H level:** Rating (5, 12 or 24 V)  $\pm$ 10 %

**L level:**  $\leq$  0.5 V

**Load resistance:**  $\geq$  1 k $\Omega$  (5 V),  $\geq$  2.4 k $\Omega$  (12 V),  $\geq$  4.8 k $\Omega$  (24 V)

**Maximum frequency:** 100 kHz

■ **Noncontact AC/DC Switch:** 120 V AC or 120 V DC @200 mA (resistive load)

**ON resistance:** 3  $\Omega$

**Maximum frequency:** 20 Hz

**Rise time:** 5 msec.

**Sink time:** 3 msec.

### ■ RS-422 Line Driver Pulse

**Transmitter:** Conforms to RS-422

**Maximum frequency:** 100 kHz

## OUTPUT PULSE WIDTH

- **No conversion to one-shot:** Duty ratio approx. 50 %; Internal digital computation calculates the pulse width.
- **One-shot Output:** Preset pulse width  $\pm 20\%$   
Optional pulse width: 30  $\mu$ sec. – 300 msec.

## INSTALLATION

### Power input

- **AC:** Operational voltage range 85 – 132 V, 47 – 66 Hz, approx. 6 VA
- **DC:** Operational voltage range: Rating  $\pm 10\%$ , or 85 – 150 V for 110 V rating; ripple 10 %p-p max.; Approx. 3.3 W (140 mA at 24 V)

**Operating temperature:** -5 to +60°C (23 to 140°F)

**Operating humidity:** 30 to 90 %RH (non-condensing)

**Mounting:** Surface or DIN rail

**Weight:** 400 g (0.88 lb)

## PERFORMANCE

**Response time:** Sampling time + 50 msec.

The response time equals the interval between the first input pulse and the first output pulse.

**Insulation resistance:**  $\geq 100\text{ M}\Omega$  with 500 V DC

**Dielectric strength:** 2000 V AC @ 1 minute (input 1 or input 2 to output to power to ground)

## EXTERNAL VIEW

This unit is programmed and calibrated at the factory according to the Ordering Information Sheet.

Please refer to the instruction manual for the model under “Software Setting” when you need to modify certain specifications.

DO NOT change setting of unused switches and adjusters.

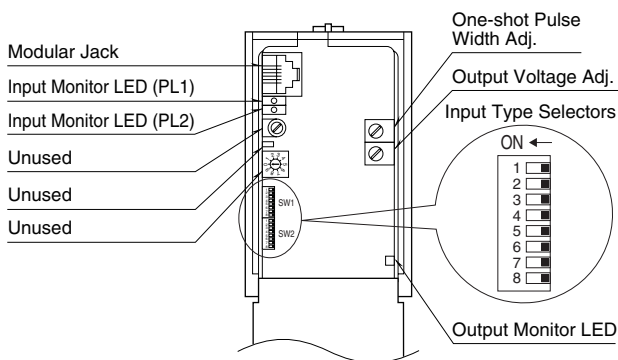

**OUTPUT LOGIC**

OUTPUT WAVEFORM		INPUT 1 & 2 WAVEFORM	Voltage Pulse 2-wire Current Pulse	Open Collector or Mechanical Contact
			H L	OFF ON
Voltage Pulse or RS-422 Line Driver Pulse	Non Inverted *1	No conversion to one-shot	H L	H L
		One-shot, detecting input pulse rise	H L	H L
		One-shot, detecting input pulse drop	H L	H L
	Inverted *1	No conversion to one-shot	H L	H L
		One-shot, detecting input pulse rise	H L	H L
		One-shot, detecting input pulse drop	H L	H L
Open collector or Noncontact AC/DC Switch	Non Inverted *1	No conversion to one-shot	OFF ON	OFF ON
		One-shot, detecting input pulse rise	OFF ON	OFF ON
		One-shot, detecting input pulse drop	OFF ON	OFF ON
	Inverted *1	No conversion to one-shot	OFF ON	OFF ON
		One-shot, detecting input pulse rise	OFF ON	OFF ON
		One-shot, detecting input pulse drop	OFF ON	OFF ON

The pulse width in one-shot means the bold lined section of a pulse waveform.

\*1. Specified by model number suffix code.

**EXTERNAL DIMENSIONS & TERMINAL ASSIGNMENTS unit: mm (inch)**

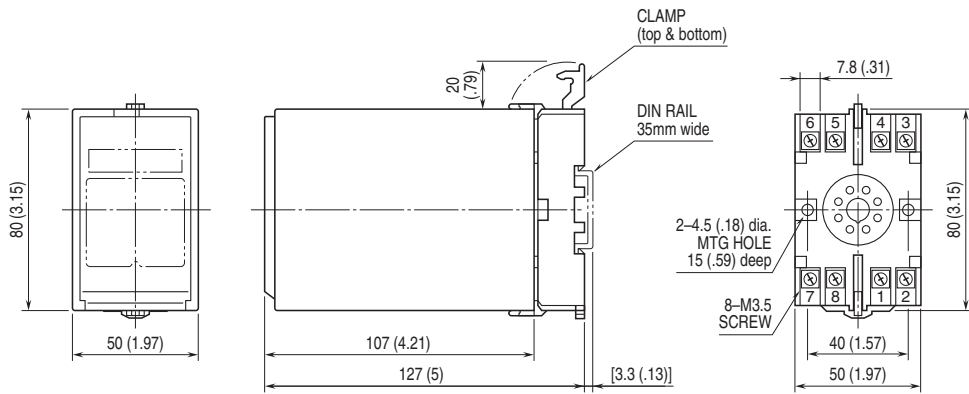

• When mounting, no extra space is needed between units.

## SCHEMATIC CIRCUITRY & CONNECTION DIAGRAM

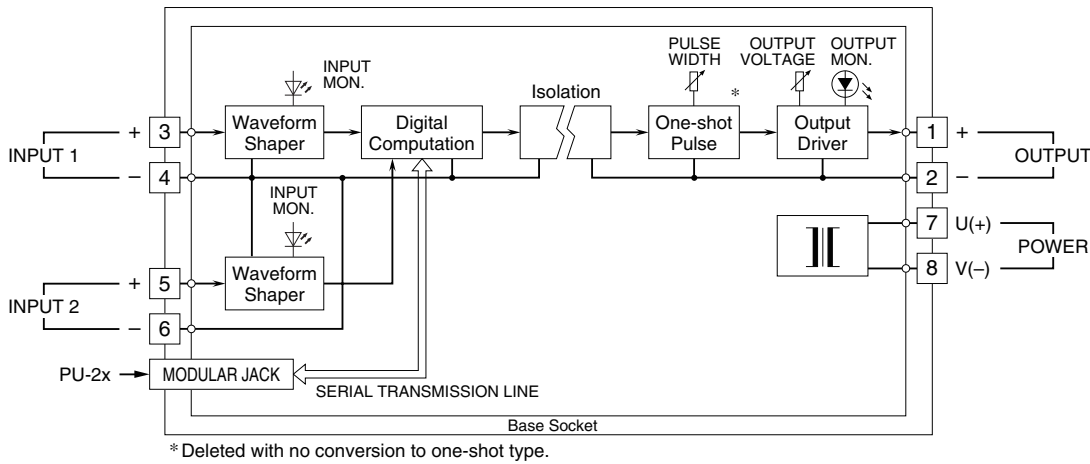

### Input Connection Examples

#### ■ Open Collector or Mechanical Contact

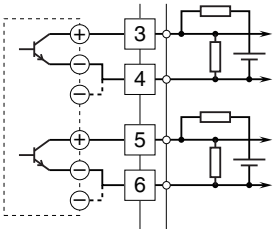

#### ■ Voltage Pulse

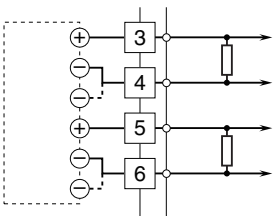

#### ■ 2-Wire Current Pulse

##### • External DC Supply

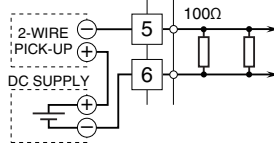
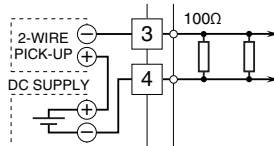

### Output Connection Examples

#### ■ Open Collector

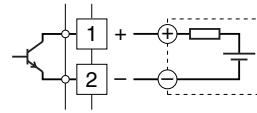

#### ■ Voltage Pulse

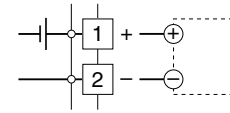

#### ■ Noncontact AC/DC Switch

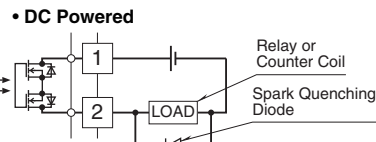
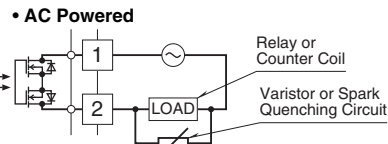

#### ■ RS-422 Line Driver Pulse

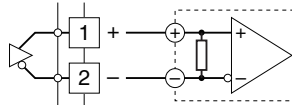

Specifications are subject to change without notice.