

<b>FREQUENCY TRANSMITTER</b>	MODEL <b>W5PA</b>
------------------------------	-------------------

**BEFORE USE ....**

Thank you for choosing M-System. Before use, please check contents of the package you received as outlined below. If you have any problems or questions with the product, please contact M-System's Sales Office or representatives.

**■ PACKAGE INCLUDES:**

Signal conditioner .....(1)

**■ MODEL NO.**

Confirm Model No. marking on the product to be exactly what you ordered.

**■ INSTRUCTION MANUAL**

This manual describes necessary points of caution when you use this product, including installation, connection and basic maintenance procedures.

**POINTS OF CAUTION**

**■ CONFORMITY WITH EU DIRECTIVES**

- The equipment must be mounted inside a panel.
- The actual installation environments such as panel configurations, connected devices, connected wires, may affect the protection level of this unit when it is integrated in a panel system. The user may have to review the CE requirements in regard to the whole system and employ additional protective measures to ensure the CE conformity.
- Install lightning surge protectors for those wires connected to remote locations.

**■ POWER INPUT RATING & OPERATIONAL RANGE**

- Locate the power input rating marked on the product and confirm its operational range as indicated below:
  - 85 – 264V AC rating: 85 – 264V, 47 – 66 Hz, approx. 6 – 8VA
  - 24V DC rating: 24V ±10%, approx. 3W
  - 11 – 27V DC rating: 11 – 27V, approx. 3W
  - 110V DC rating: 85 – 150V, approx. 3W

**■ GENERAL PRECAUTIONS**

- Before you remove the unit or mount it, turn off the power supply and input signal for safety.

**■ ENVIRONMENT**

- Indoor use.
- When heavy dust or metal particles are present in the air, install the unit inside proper housing with sufficient ventilation.
- Do not install the unit where it is subjected to continuous vibration. Do not subject the unit to physical impact.
- Environmental temperature must be within -5 to +55°C (23 to 131°F) with relative humidity within 0 to 90% RH in order to ensure adequate life span and operation.

**■ WIRING**

- Do not install cables close to noise sources (relay drive cable, high frequency line, etc.).
- Do not bind these cables together with those in which noises are present. Do not install them in the same duct.

- Install lightning surge protectors for those wires connected to remote locations. For 24V DC power supply line, choose a surge protector with its maximum surge voltage 40V or less between lines. Recommended M-System model: MDP-D24.

**■ AND ....**

- The unit is designed to function as soon as power is supplied, however, a warm up for 10 minutes is required for satisfying complete performance described in the data sheet.

**COMPONENT IDENTIFICATION**

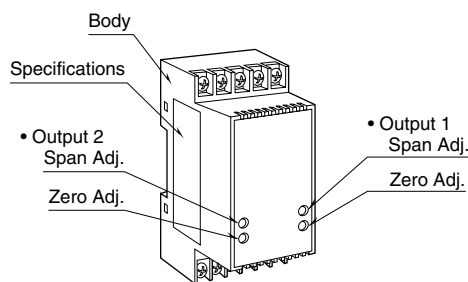

**INSTALLATION**

Set the unit so that its DIN rail adapter is at the bottom.

**■ MOUNTING THE UNIT ON A DIN RAIL**

- A) Hang the upper hook at the rear side of unit on the DIN rail.
- B) Push in the lower in keeping pressing the unit to the DIN rail.

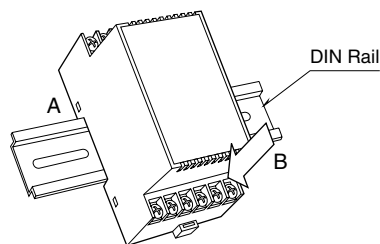

**■ REMOVING THE UNIT**

- A) Push down the DIN rail adaptor using a minus screwdriver.
- B) Pull out the lower part of the unit.
- C) Remove the upper part from the DIN rail.

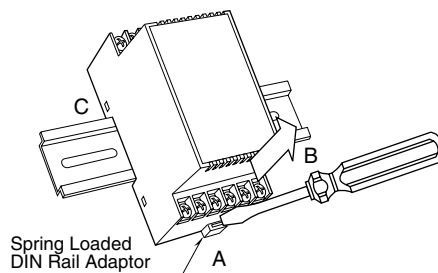

# TERMINAL CONNECTIONS

Connect the unit as in the diagram below or refer to the connection diagram on the front of the unit.

## EXTERNAL DIMENSIONS unit: mm (inch)

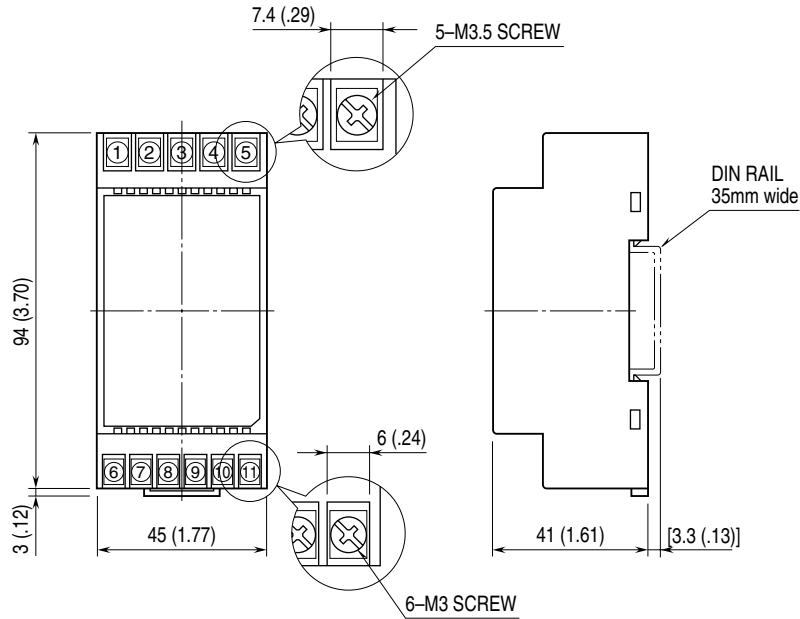

• When mounting, no extra space is needed between units.

## CONNECTION DIAGRAM

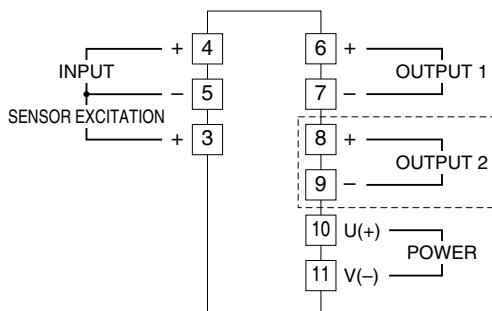

The section enclosed by broken line is only with 2nd output option.  
DO NOT connect to the terminals 1 and 2.

### Input Connection Examples

#### Open Collector or Mechanical Contact

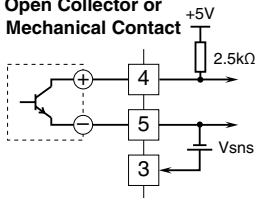

#### Voltage Pulse

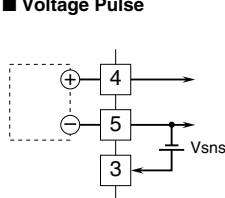

## WIRING INSTRUCTIONS

### M3 Screw (output, power input)

Torque: 0.8 N·m

### M3.5 Screw (input)

Torque: 0.8 N·m

---

## CHECKING

- 1) Terminal wiring: Check that all cables are correctly connected according to the connection diagram.
- 2) Power input voltage: Check voltage across the terminal 10 – 11 with a multimeter.
- 3) Input: Check that the input signal is within 0 – 100% of the full-scale.
- 4) Output: Check that the load resistance meets the described specifications.

---

## ADJUSTMENT PROCEDURE

This unit is calibrated at the factory to meet the ordered specifications, therefore you usually do not need any calibration.

For matching the signal to a receiving instrument or in case of regular calibration, adjust the output as explained in the following.

### ■ HOW TO CALIBRATE THE OUTPUT SIGNAL

Use a signal source and measuring instruments of sufficient accuracy level. Turn the power supply on and warm up for more than 10 minutes.

- 1) ZERO: Apply 0% input and adjust output to 0%.
- 2) SPAN: Apply 100% input and adjust output to 100%.
- 3) Check ZERO adjustment again with 0% input.
- 4) When ZERO value is changed, repeat the above procedure 1) – 3).
- 5) Go through the same procedure for the output 2.  
Calibration for the output 1 affects the output 2. Check the output 2 whenever the output 1 is adjusted.

---

## MAINTENANCE

Regular calibration procedure is explained below:

### ■ CALIBRATION

Warm up the unit for at least 10 minutes. Apply 0%, 25%, 50%, 75% and 100% input signal. Check that the output signal for the respective input signal remains within accuracy described in the data sheet. When the output is out of tolerance, recalibrate the unit according to the “ADJUSTMENT PROCEDURE” explained earlier.

---

## LIGHTNING SURGE PROTECTION

M-System offers a series of lightning surge protector for protection against induced lightning surges. Please contact M-System to choose appropriate models.