

BEFORE USE

Thank you for choosing M-System. Before use, please check contents of the package you received as outlined below.

If you have any problems or questions with the product, please contact M-System's Sales Office or representatives.

■ PACKAGE INCLUDES:

- Discrete output module.....(1)
- Terminating resistor (110 Ω, 0.5 W).....(1)

■ MODEL NO.

Confirm Model No. marking on the product to be exactly what you ordered.

■ INSTRUCTION MANUAL

This manual describes necessary points of caution when you use this product, including installation, connection and basic maintenance procedures.

POINTS OF CAUTION

■ NONINCENDIVE APPROVAL OPTION

- This equipment is suitable for use in Class I, Division 2, Groups A, B, C, D or Non-Hazardous Locations only.
- **WARNING! – Explosion Hazard –**
Substitution of any component may impair suitability for Class I, Division 2.
- **WARNING! – Explosion Hazard –**
DO NOT disconnect while the circuit is live or unless the area is known to be free of ignitable concentrations.
- Temperature Code of this equipment is T5 and the Maximum Ambient Temperature is 55°C (Surrounding Temperature inside the fire enclosure).

■ CONFORMITY WITH UL APPROVAL

- This equipment is suitable for use in Installation Category II and in a Pollution Degree 2 environment.
- Altitude up to 2000 meters.
- This equipment must be mounted inside a suitable fire enclosure.
- This equipment is to be supplied by a Class 2 power supply.

■ CONFORMITY WITH EU DIRECTIVES

- The equipment must be mounted inside the instrument panel of a metal enclosure.
- The actual installation environments such as panel configurations, connected devices, connected wires, may affect the protection level of this unit when it is integrated in a panel system. The user may have to review the CE requirements in regard to the whole system and employ additional protective measures to ensure the CE conformity.
- Install lightning surge protectors for those wires connected to remote locations. Choose a surge protector with its maximum surge voltage 40V or less between lines. Recommended M-System model: MDP-D24.

■ POWER INPUT RATING & OPERATIONAL RANG

- Locate the power input rating marked on the product and confirm its operational range as indicated below:
24V DC rating: 24V ±10%, approx. 75mA

■ GENERAL PRECAUTIONS

- Before you remove the unit or mount it, turn off the power supply and output signal for safety.
- DO NOT set the switches on the module while the power is supplied. The switches are used only for maintenance without the power.

■ ENVIRONMENT

- Indoor use.
- When heavy dust or metal particles are present in the air, install the unit inside proper housing with sufficient ventilation.
- Do not install the unit where it is subjected to continuous vibration. Do not subject the unit to physical impact.
- Environmental temperature must be within -10 to +55°C (14 to 131°F) with relative humidity within 30 to 90% RH in order to ensure adequate life span and operation.

■ WIRING

- Do not install cables close to noise sources (relay drive cable, high frequency line, etc.).
- Do not bind these cables together with those in which noises are present. Do not install them in the same duct.

■ AND

- The unit is designed to function as soon as power is supplied, however, a warm up for 10 minutes is required for satisfying complete performance described in the data sheet.

COMPONENT IDENTIFICATION

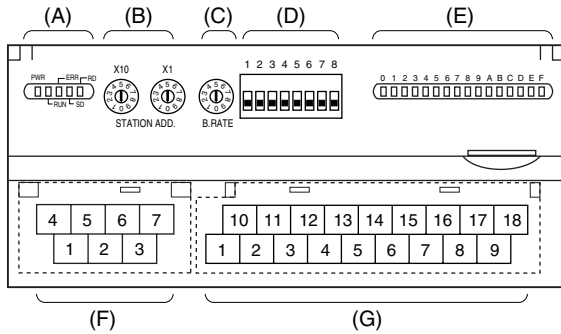

- (A) Status Indicator LED *1
- (B) Station Address Setting Rotary SW
- (C) Baud Rate Setting Rotary SW
- (D) Operating Mode Setting DIP SW (SW1)
- (E) Discrete Output Status Indicator LED
- (F) CC-Link, Power Supply Terminals
- (G) Output Terminals

*1. Refer to 'Status Indicator LED' section for detailed information.

STATUS INDICATOR LED

ID	COLOR	FUNCTION
PWR	Red	Turns on when the internal 5V is supplied normally.
RUN	Red	Turns on when the refresh data is received normally.
ERR	Red	Turns on when the received data is abnormal.
SD	Red	Turns on when the module is transmitting.
RD	Red	Turns on when the module is receiving.

STATION ADDRESS

Station Address is selected between 1 and 64 in decimal. The left switch determines the tenth place digit, while the right switch does the ones place digit of the address.

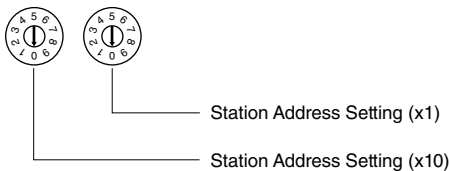

BAUD RATE

Baud Rate is selected with the rotary switch.

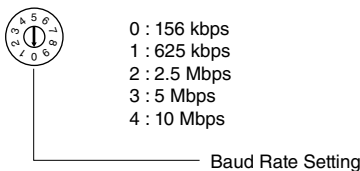

OPERATING MODE

(*) Factory setting

Extension (SW1-1, 1-2, 1-3, 1-4)

SW1-1	SW1-2	SW1-3	SW1-4	EXTENSION
OFF	ON	OFF	OFF	No extension (*)
OFF	ON	OFF	ON	Discrete output, 8 or 16 points

Output at the loss of communication (SW1-5)

SW1-5	OUTPUT AT THE LOSS OF COMMUNICATION
OFF	Reset the output (turned off)
ON	Hold the output (*) (maintains the last data received normally)

Note: Be sure to set unused SW1-6 through 1-8 to OFF.

POWER SUPPLY, CC-LINK TERMINAL ASSIGNMENT

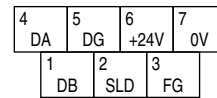

NO.	ID	FUNCTION, NOTES
1	DB	White
2	SLD	Shield
3	FG	FG
4	DA	Blue
5	DG	Yellow
6	+24V	Power input (24V DC)
7	0V	Power input (0V)

OUTPUT TERMINAL ASSIGNMENT

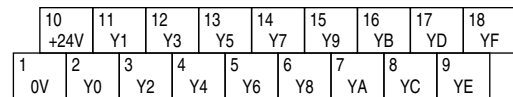

NO.	ID	FUNCTION	NO.	ID	FUNCTION
1	0V	0V (common)	10	+24V	24V DC
2	Y0	Output 0	11	Y1	Output 1
3	Y2	Output 2	12	Y3	Output 3
4	Y4	Output 4	13	Y5	Output 5
5	Y6	Output 6	14	Y7	Output 7
6	Y8	Output 8	15	Y9	Output 9
7	YA	Output 10	16	YB	Output 11
8	YC	Output 12	17	YD	Output 13
9	YE	Output 14	18	YF	Output 15

EXTENSION MODULE

Combinations with the R7C-EC8A, R7C-EC16A, R7C-EC8B, R7C-EC16B or R7C-EC8C are selectable.

INDICATOR LED

■ STATUS INDICATOR LED

PWR	RUN	ERR	SD *1	RD	STATUS *2
ON	ON	BL	BL	ON	Communicates normally with occasional CRC errors due to noise interference.
ON	ON	BL	BL	ON	Communicates normally but the Baud Rate and/or Station Address switches failed. ERR LED blinks approximately in 0.5 seconds intervals.
ON	ON	BL	BL	OFF	----
ON	ON	BL	OFF	ON	CRC error found in the received data. Unable to respond.
ON	ON	BL	OFF	OFF	----
ON	ON	OFF	BL	ON	Normal communication
ON	ON	OFF	BL	OFF	----
ON	ON	OFF	OFF	ON	Unable to receive data addressed to the station.
ON	ON	OFF	OFF	OFF	----
ON	OFF	BL	BL	ON	Performs the interval-timed responses but CRC error found in receiving the refresh data.
ON	OFF	BL	BL	OFF	----
ON	OFF	BL	OFF	ON	CRC error found in the data addressed to the station.
ON	OFF	BL	OFF	OFF	----
ON	OFF	OFF	BL	ON	Link is not started.
ON	OFF	OFF	BL	OFF	----
ON	OFF	OFF	OFF	ON	No data addressed to the station. Or unable to receive data addressed to the station due to noise interference. (Missing parts of the data sent from the master)
ON	OFF	OFF	OFF	OFF	Unable to receive data due to wire breakdown
ON	OFF	ON	OFF	ON/OFF	Faulty Baud Rate and/or Station Address setting
OFF	OFF	OFF	OFF	OFF	Power input removed. Or power supply failure.

OFF = OFF, ON = ON, BL = Blinking

*1. SD LED may look not blinking but ON with high baud rate and fewer connected modules.

*2. LEDs indicated with "----" in STATUS rarely occurs in normal operation (LED failure or the like as possible cause).

■ DISCRETE OUTPUT STATUS INDICATOR LED

LED indicators show the signal status.

ON : LED ON

OFF : LED OFF

PC CONFIGURATOR

With configurator software, settings shown below are available.

Refer to the software manual of R7CON for detailed operation.

■ INTERFACE MODULE SETTING

PARAMETER	AVAILABLE RANGE	DEFAULT SETTING
Communication Timeout	0.0 – 3276.7 (sec.)	1.0 (sec.)

COMMUNICATION CABLE CONNECTIONS

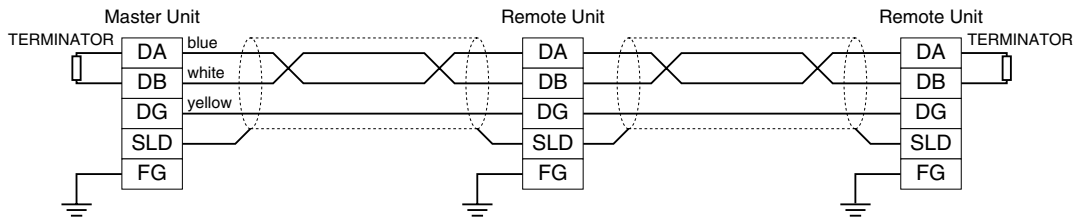

Be sure to connect the terminating resistor included in the product package to the unit at both ends of communication line.
 The terminator must be connected across DA and DB.
 The Master Unit can be located other than at the extreme ends of communication line.

DATA ALLOCATION

■ R7C-DC16x

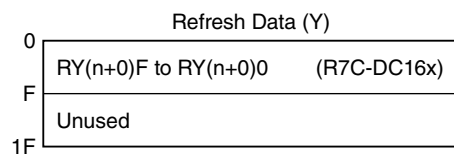
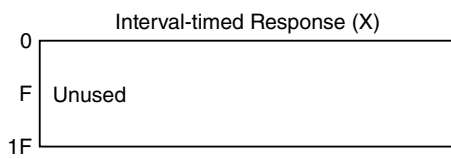

■ R7C-DC16x + R7C-EC16x

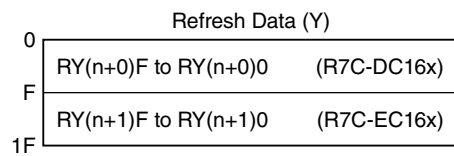
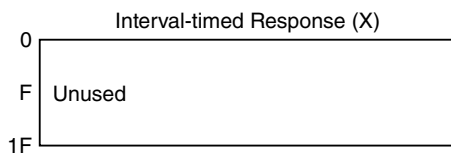

I/O DATA DESCRIPTIONS

■ DISCRETE OUTPUT

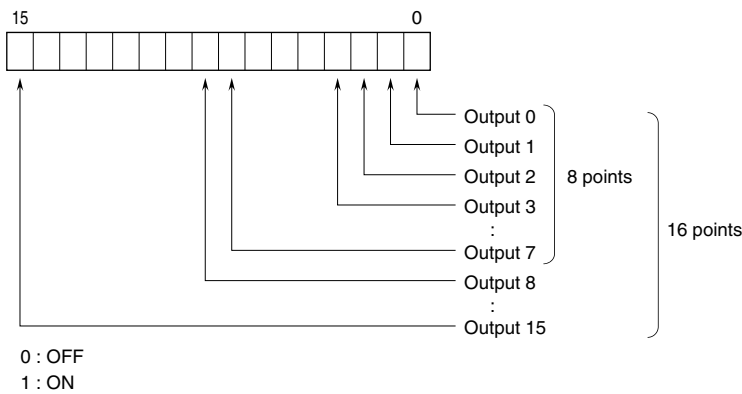

WIRING INSTRUCTIONS

■ SCREW TERMINAL

Torque: 0.5 N·m

■ SOLDERLESS TERMINAL

Refer to the drawing below for recommended ring tongue terminal size. Spade tongue type is also applicable.

Applicable wire size: 0.25 to 1.65 mm² (AWG 22 to 16)

Recommended manufacturer: Japan Solderless Terminal MFG. Co., Ltd, Nichifu Co., Ltd

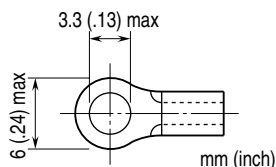

CONFORMITY WITH CE MARKING

■ CE MARKING

CE marking requires to integrate safety regulations existed in each country in EU territory and to secure smooth distribution of products of which safety is guaranteed. It is mandatory by law that products distributed and sold in EU territory to have CE mark which shows that the product conforms with the requirements of EU Directive. Each EU Directive describes the scope of apparatuses to which that EU Directive is applied. M-System's R7C must conform with EMC Directive.

Each Directive states only basic requirements. In order to mark the CE on an assembled machinery equipment, its manufacturer needs to check the overall conformity with Directives applicable to it.

■ WARNINGS AND CAUTIONS WHEN INSTALLING THE R7C

The R7C needs to be installed in a control panel. This is effective not only to ensure general safety but also to contain noise emissions by the R7C inside the control panel. We conduct a series of testing to see that the product conforms to EMC Directive while it is installed in the control panel.

Warning and cautions when installing R7C are stated below.

- Use control panels with an internal panel plate, both made of metal, when installing the R7C.
- Make sure to adequately ground the control panel and the internal panel plate with a thick cable to maintain low impedance at high frequency.
- Use shielded cables for the signals taken out of the control panel.
- Choose a thick and short cable to ground the FG terminal of the R7C module to the internal panel plate of the control panel.
Note: If electromagnetic radiation disturbance increases by grounding the FG terminal, remove the grounding.
- When painting the internal plate of the control panel, apply masking to expose metal surface to secure conductivity at the sections where the following parts are attached:
 - Bolts attaching the internal panel to the control panel
 - Ground for the FG of the R7C module
 - Earth clamp on the shielded cable
- Noise emissions inside the control panel might leak through its openings. Design them as small as possible. Recommended diameter is 10 cm or less.

Supplement:

Additional measures may be taken depending upon actual installation sites. These points of cautions are illustrated in the next page.

- Prevent noise leakage by wrapping cables using shield covers, shield tubes and flexible conduits etc. if noise leaks through the cable outlet.
- Use an electromagnetic shield gasket and block up the gap between the control panel cabinet and its cover, if noise leaks through it.
- Connecting the internal panel plate and the cover of the control panel to the main cabinet using an earth strap may be effective to strengthen the grounding.
- Electromagnetically shielded control panel cabinet is effective for shielding.

• Points of cautions applicable when installing the R7C Series

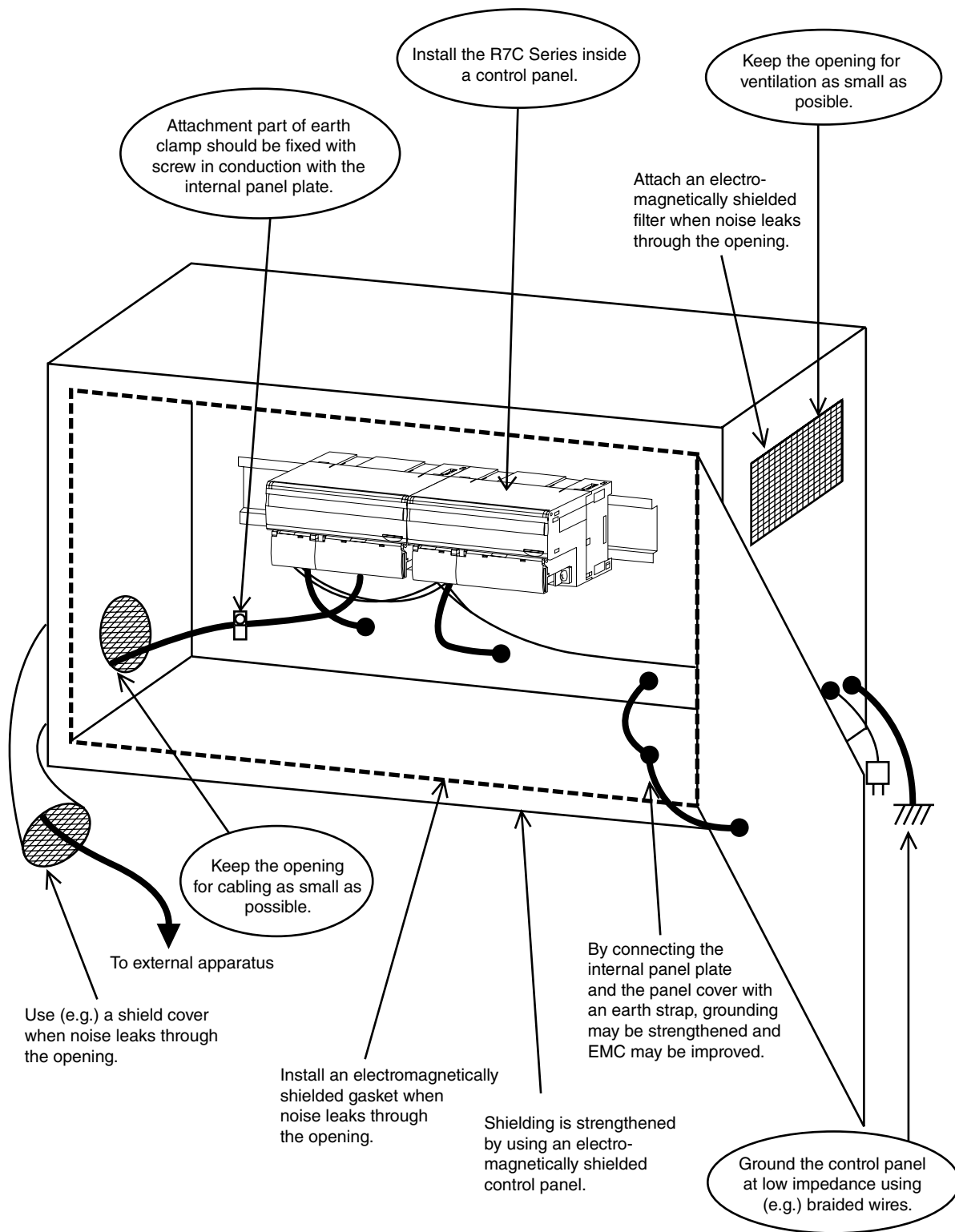

■ WARNINGS AND CAUTIONS WHEN LAYING CABLES

Signal cables connected to the R7C contain high-frequency components. Since these cables have the same effect as an antenna, they emit these high-frequency components to the external space as noise or overlaps noise from the external space on themselves.

Cables with shielding should be used for the signal line due to the above reason.

EMC conformance test is conducted in the condition that shielded cables and earth clamps are used with the R7C.

Warning and cautions when laying cables are stated below. These points of cautions are illustrated in the next page.

- Use shielded cables for those signal cables installed out of the control panel and for thermocouple and RTD extension wires.
- All the network cables connected to R7C should be shielded.
- Use exclusively designed cables for the CC-Link.
- Expose the shield at a part of the cable cover, clip it with an earth clamp, and ground it to the internal panel of the control panel. A drain wire connected to the panel in a pig-tail form cannot maintain low impedance against high-frequency noise, thus grounding (noise shielding) in this form will not be effective.

Supplement:

Additional measures may be taken depending upon actual installation sites. These points of cautions are illustrated in the next page.

- Keep cables as short as possible. It prevents noise emissions from the cables and noise overlapping to the cables.
- Attach a ferrite core to reduce noise impact to the signal cables susceptible to the noise. Ferrite core can be attached close to the cable outlet of the control panel or close to the I/O terminal or connector, whichever is more effective. Also, the impact might be reduced by winding the cable around the ferrite core for extra turns or attaching multiple ferrite cores.
- Keep cables which are easily affected by noise away from those which can be a noise source.

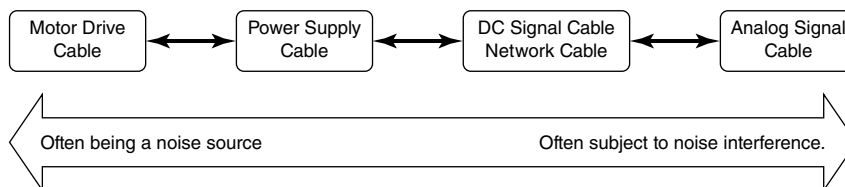

In the following are examples of effective ways to lay cables separately:

- Keeping physical distance (farther than 20 cm from motor drive cables, farther than 10 cm for other groups).
- Dividing off by a grounded metal plate
- Grouping into separate grounded metal pipes or cable shields.

Wires on each side of a filter should not be too close to each other. Noise could ride onto the other side of cable.

Extra attention needs to be paid at the following parts.

- Noise filter that is enclosed in power cables.
- Ferrite core that is attached to signal cables.
- Noise limiting circuit (surge quenching circuit, transient absorber circuit, etc.) that is enclosed in signal cables.

• Points of cautions applicable when wiring the R7C Series

