

**PULSE SCALER**  
(pulse dividing; selectable range)

MODEL **PDU**

**BEFORE USE ....**

Thank you for choosing M-System. Before use, please check contents of the package you received as outlined below. If you have any problems or questions with the product, please contact M-System's Sales Office or representatives.

**■ PACKAGE INCLUDES:**

Signal conditioner (body + base socket).....(1)

**■ MODEL NO.**

Confirm Model No. marking on the product to be exactly what you ordered.

**■ INSTRUCTION MANUAL**

This manual describes necessary points of caution when you use this product, including installation, connection and basic maintenance procedures.

This unit is factory adjusted and calibrated according to the Ordering Information included in the product package. If you don't need to change the pre-adjusted setting, you can skip the sections on hardware setting and calibration in this manual.

**POINTS OF CAUTION**

**■ POWER INPUT RATING & OPERATIONAL RANGE**

- Locate the power input rating marked on the product and confirm its operational range as indicated below:

**AC power:** Rating ±10%, 50/60 ±2 Hz, approx. 2VA

**DC power:** Rating ±10%, approx. 2W

**■ GENERAL PRECAUTIONS**

- Before you remove the unit from its base socket or mount it, turn off the power supply and input signal for safety.

**■ ENVIRONMENT**

- Indoor use.
- When heavy dust or metal particles are present in the air, install the unit inside proper housing with sufficient ventilation.
- Do not install the unit where it is subjected to continuous vibration. Do not subject the unit to physical impact.
- Environmental temperature must be within -5 to +60°C (23 to 140°F) with relative humidity within 30 to 90% RH in order to ensure adequate life span and operation.

**■ WIRING**

- Do not install cables close to noise sources (relay drive cable, high frequency line, etc.).
- Do not bind these cables together with those in which noises are present. Do not install them in the same duct.

**■ AND ....**

- The unit is designed to function as soon as power is supplied, however, a warm up for 10 minutes is required for satisfying complete performance described in the data sheet.

**COMPONENT IDENTIFICATION**

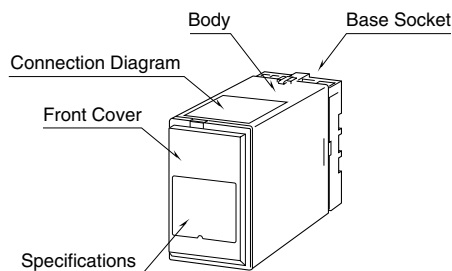

**■ HOW TO OPEN THE FRONT COVER:**

Hang your finger on the hook at the top of the front cover and pull.

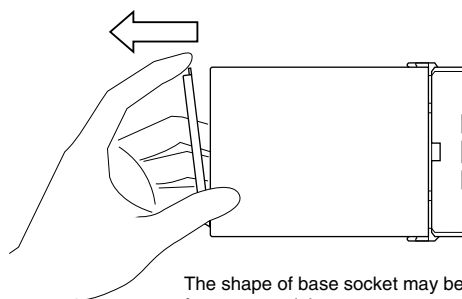

The shape of base socket may be different for some models.

**■ FRONT PANEL CONFIGURATIONS**

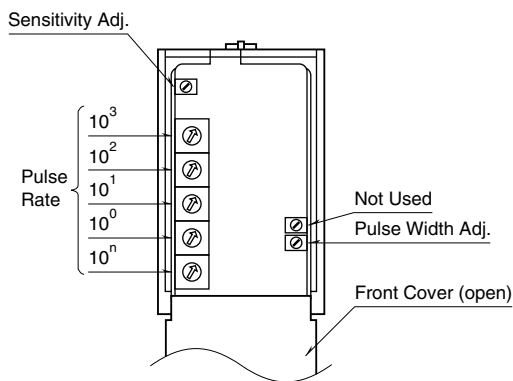

- **Pulse rate adjustment:** switches are assigned as shown in the equation below.

$$\text{Pulse Rate} = \frac{1}{XX} = \frac{1}{(10^3)(10^2)(10^1)(10^0) \times 10^n}$$

where n = 0 thr. 6

[Example]

$$\text{Pulse Rate} = \frac{1}{10} = \frac{1}{0010 \times 10^0}$$

where (10<sup>3</sup>) = 0, (10<sup>2</sup>) = 0, (10<sup>1</sup>) = 1, (10<sup>0</sup>) = 0, n = 0.

- **Sensitivity adjustment:** threshold level for voltage input; factory adjusted. Use only when the input pulse amplitude is not large enough. Turning the adjustment clockwise increases the threshold up to +7V, while turning it counterclockwise decreases the threshold down to -7V.
- **Pulse width adjustment:** factory adjusted. Use only when the output device (counter) is not able to read the output pulses. Adjustable within 5 μsec. thr. 200 μsec. (or 0.18 msec. thr. 9 msec., or 9 msec. thr. 400 msec.)

Turn off the power supply to the unit before changing the pulse rate (The output pulse may not be recovered immediately after you have changed switch positions while the power is supplied).

## INSTALLATION

Detach the yellow clamps located at the top and bottom of the unit for separate the body from the base socket.

### ■ DIN RAIL MOUNTING

Set the base socket so that its DIN rail adaptor is at the bottom. Hang the upper hook at the rear side of base socket on the DIN rail and push in the lower. When removing the socket, push down the DIN rail adaptor utilizing a minus screwdriver and pull.

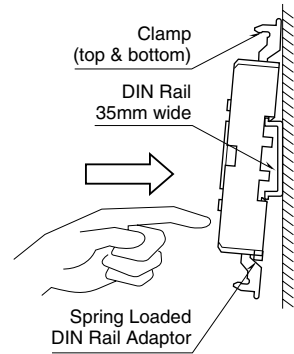

### ■ WALL MOUNTING

Refer to “EXTERNAL DIMENSIONS.”

Shape and size of the base socket are slightly different with various socket types.

## TERMINAL CONNECTIONS

Connect the unit as in the diagram below or refer to the connection diagram on the top of the unit.

### ■ EXTERNAL DIMENSIONS unit: mm (inch)

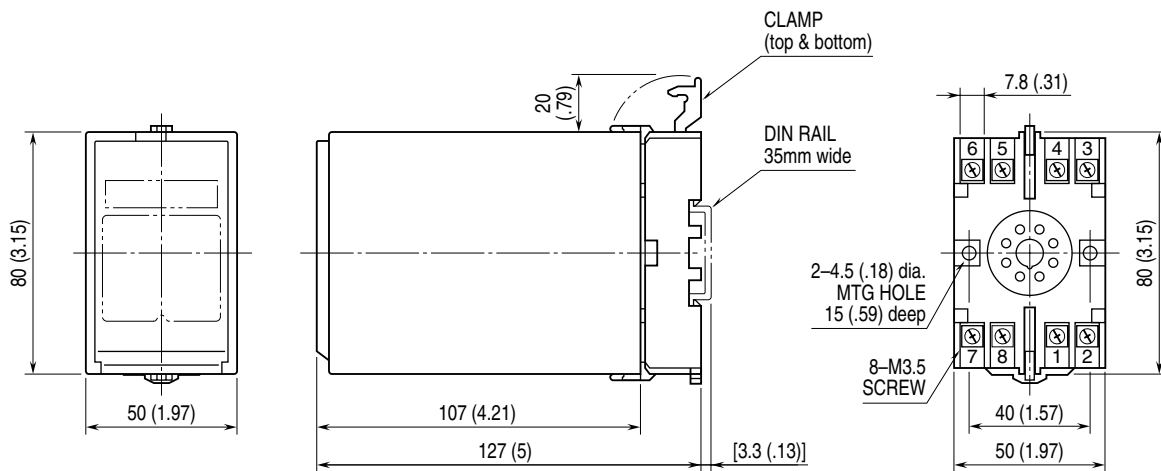

- When mounting, no extra space is needed between units.

CONNECTION DIAGRAM

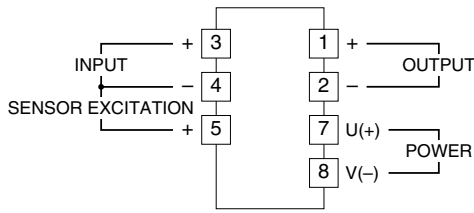

Input Connection Examples

■ Dry Contact

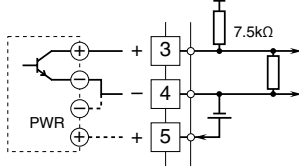

■ 2-Wire Current Pulse  
• Built-in Excitation

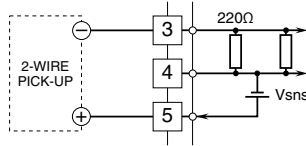

Output Connection Examples

■ Open Collector

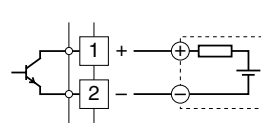

■ Voltage Pulse

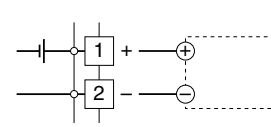

■ Voltage Pulse

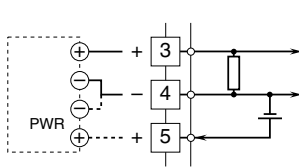

• External DC Supply

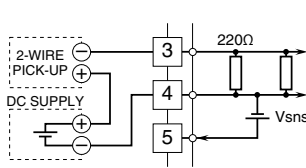

■ Relay Contact  
• AC Powered

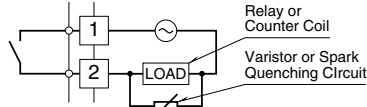

• DC Powered

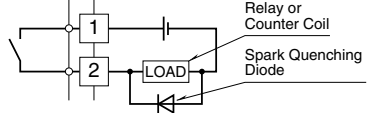

OUTPUT PULSE LOGIC

INPUT TYPE	PULSE LOGIC	INPUT	VOLTAGE PULSE OUTPUT	OPEN COLLECTOR or RELAY CONTACT
Voltage Pulse Input 2-wire Current Pulse Input [ON current (H)] [OFF current (L)]	Non Inverted	H	H	OFF
	Inverted	H	H	OFF
Dry Contact Input	Non Inverted	OFF	H	OFF
	Inverted	OFF	H	OFF

The pulse width in one-shot means the bold lined section of a pulse waveform.

CHECKING

- Terminal wiring: Check that all cables are correctly connected according to the connection diagram.
- Power input voltage: Check voltage across the terminal 7 – 8 with a multimeter.
- Input: Check the input signal across the terminal 3 – 4 with an oscilloscope.
- Output load: Check the output load according to the table below.

OUTPUT	LOAD
Open collector	50V DC @50mA max.
5V pulse	1kΩ minimum
12V pulse	2.4kΩ minimum
24V pulse	4.8kΩ minimum
Relay contact	30V DC @ 200mA (resistive load) 120V AC @ 200mA (cos φ=1)

LIGHTNING SURGE PROTECTION

M-System offers a series of lightning surge protector for protection against induced lightning surges. Please contact M-System to choose appropriate models.