

CURRENT LOOP SUPPLY
(applicable to HART signal, opencircuit detection selectable)

MODEL **18KDYH2**

BEFORE USE

Thank you for choosing M-System. Before use, please check contents of the package you received as outlined below. If you have any problems or questions with the product, please contact M-System's Sales Office or representatives.

■ **PACKAGE INCLUDES:**

Signal conditioner(1)

■ **MODEL NO.**

Confirm Model No. marking on the product to be exactly what you ordered.

■ **INSTRUCTION MANUAL**

This manual describes necessary points of caution when you use this product, including installation, connection and basic maintenance procedures.

POINTS OF CAUTION

■ **POWER INPUT RATING & OPERATIONAL RANGE**

- Locate the power input rating marked on the product and confirm its operational range as indicated below:
24V DC rating: 24V ±10%, approx. 120mA

■ **GENERAL PRECAUTIONS**

- Before you remove the unit or mount it, turn off the power supply and input signal for safety.

■ **ENVIRONMENT**

- Indoor use.
- When heavy dust or metal particles are present in the air, install the unit inside proper housing with sufficient ventilation.
- Do not install the unit where it is subjected to continuous vibration. Do not subject the unit to physical impact.
- Environmental temperature must be within -5 to +55°C (23 to 131°F) with relative humidity within 30 to 90% RH in order to ensure adequate life span and operation.

■ **WIRING**

- Do not install cables close to noise sources (relay drive cable, high frequency line, etc.).
- Do not bind these cables together with those in which noises are present. Do not install them in the same duct.

■ **AND**

- The unit is designed to function as soon as power is supplied, however, a warm up for 10 minutes is required for satisfying complete performance described in the data sheet.

COMPONENT IDENTIFICATION

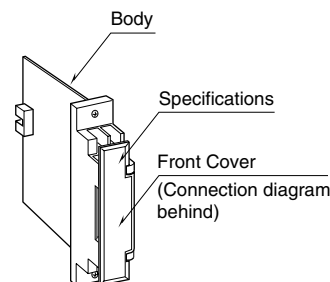

■ **FRONT PANEL CONFIGURATION**

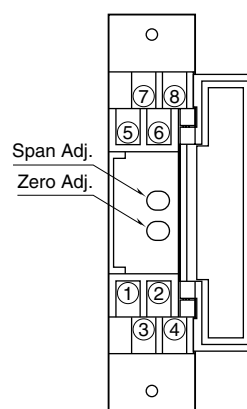

INSTALLATION

Use Standard Rack (model: 18KBXx).

TERMINAL CONNECTIONS

Connect the unit as in the diagram below or refer to the connection diagram behind the front cover.

EXTERNAL DIMENSIONS unit: mm (inch)

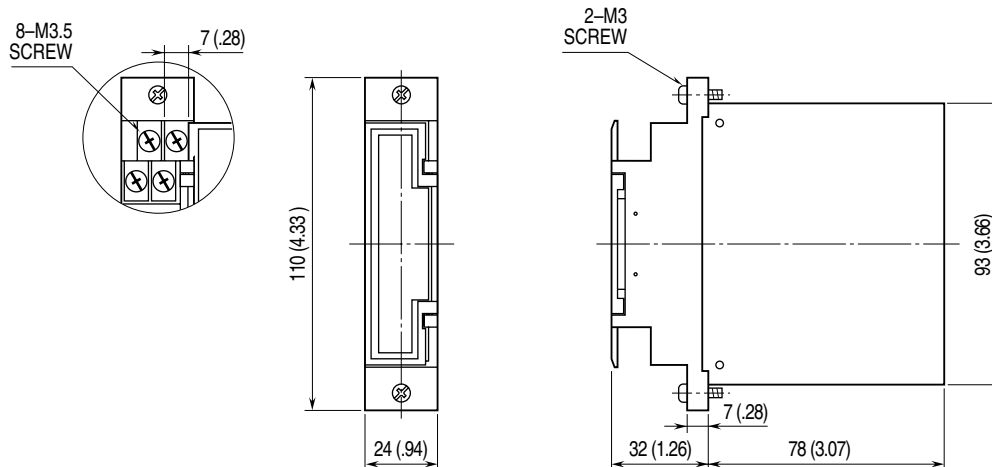

CONNECTION DIAGRAM

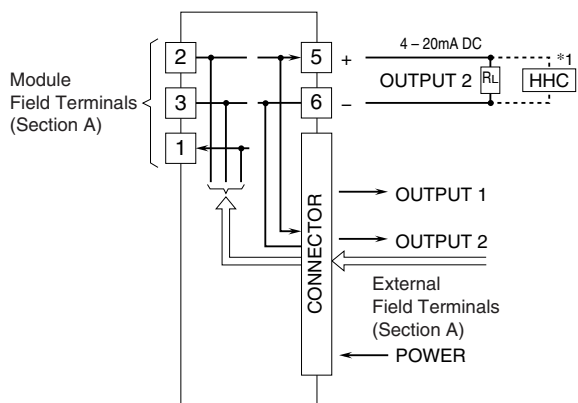

TERMINAL ASSIGNMENTS

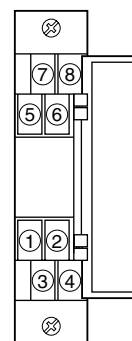

Note 1: Use either of module or external field terminals.
 Note 2: For OUTPUT 2, use either of terminals on the front or connector on the rear.
 *1. Hand-held communicator

Section A. Field Terminals

When used as DC Supply

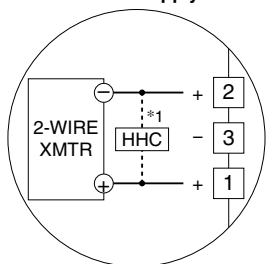

When used as Isolator

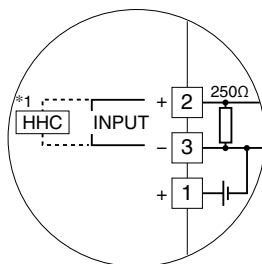

WIRING INSTRUCTIONS

■ SCREW TERMINAL

Torque: 0.8 N·m

CHECKING

- 1) Terminal wiring: Check that all cables are correctly connected according to the connection diagram.
- 2) Power input voltage: Check voltage supplied to the rack (model: 18KBXx). For the DC power source, be sure that the ripple level is within 10% p-p.
- 3) Input: Check that the input signal is within 0 – 100% of the full-scale.
- 4) Output: Check that the load resistance meets the described specifications. For HART communication, the resistance must be $250 \Omega \pm 10\%$.

ADJUSTMENT PROCEDURE

This unit is calibrated at the factory to meet the ordered specifications, therefore you usually do not need any calibration.

For matching the signal to a receiving instrument or in case of regular calibration, adjust the output as explained in the following.

■ HOW TO CALIBRATE THE OUTPUT 1

Use a signal source and measuring instruments of sufficient accuracy level. Turn the power supply on and warm up for more than 10 minutes.

- 1) ZERO: Apply 0% input and adjust output to 0%.
- 2) SPAN: Apply 100% input and adjust output to 100%.
- 3) Check ZERO adjustment again with 0% input.
- 4) When ZERO value is changed, repeat the above procedure 1) – 3).
- 5) No need of adjustments for the Output 2.

MAINTENANCE

Regular calibration procedure is explained below:

■ CALIBRATION

Warm up the unit for at least 10 minutes. Apply 0%, 25%, 50%, 75% and 100% input signal. Check that the output signal for the respective input signal remains within accuracy described in the data sheet. When the output is out of tolerance, recalibrate the unit according to the “ADJUSTMENT PROCEDURE” explained earlier.

LIGHTNING SURGE PROTECTION

M-System offers a series of lightning surge protector for protection against induced lightning surges. Please contact M-System to choose appropriate models.