

Bargraph Indicators 48N Series

(See 'External View.')

BARGRAPH INDICATING ALARM

(with isolated DC output)

Functions & Features

- Displays a process variable in graphic bargraph of 101 LED segments
- Provides max. 4 alarm contact outputs
- Isolated DC signal output
- Multi-color indicator
- IP65 front cover
- Scale plate is easily replaced
- Separable terminal block

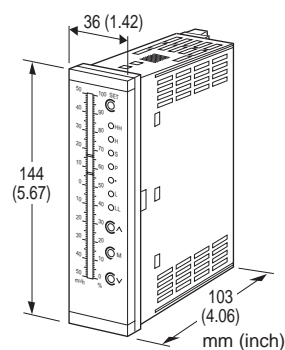

MODEL: 48NAVA-[1][2][3][4][5]-[6][7]

ORDERING INFORMATION

- Code number: 48NAVA-[1][2][3][4][5]-[6][7]
- Specify a code from below for each [1] through [7].
(e.g. 48NAVA-42V33-R/CE/D/Q)
- Special input and DC output ranges (For codes Z & 0)
- Bargraph scale (e.g. 0 - 100 %) (See 'Scale Plate.')
- Specify the specification for option code /Q
(e.g. /C01/SET)

[1] ALARM OUTPUT

- 2: 2 points
- 4: 4 points

[2] BAR LED COLOR

- R: Red
- Y: Amber
- G: Green
- B: Blue
- 1: Multi-color (red, orange and green), Pattern 1
(See 'External View.')
- 2: Multi-color (red, orange and green), Pattern 2

[3] MOUNTING DIRECTION

- V: Vertical
- H: Horizontal

[4] INPUT

Current

- A: 4 - 20 mA DC (Input resistance 10 Ω)
- B: 2 - 10 mA DC (Input resistance 20 Ω)
- C: 1 - 5 mA DC (Input resistance 39 Ω)
- D: 0 - 20 mA DC (Input resistance 10 Ω)
- E: 0 - 16 mA DC (Input resistance 12 Ω)
- F: 0 - 10 mA DC (Input resistance 20 Ω)
- G: 0 - 1 mA DC (Input resistance 200 Ω)
- H: 10 - 50 mA DC (Input resistance 5.1 Ω)
- Z: Specify current (See INPUT SPECIFICATIONS)

Voltage

- 3: 0 - 1 V DC (Input resistance 1 MΩ min.)
- 4: 0 - 10 V DC (Input resistance 1 MΩ min.)
- 5: 0 - 5 V DC (Input resistance 1 MΩ min.)
- 6: 1 - 5 V DC (Input resistance 1 MΩ min.)
- 0: Specify voltage (See INPUT SPECIFICATIONS)

[5] DC OUTPUT

Current

- A: 4 - 20 mA DC (Load resistance 550 Ω max.)
- D: 0 - 20 mA DC (Load resistance 550 Ω max.)
- Z: Specify current (See OUTPUT SPECIFICATIONS)

Voltage

- 3: 0 - 1 V DC (Load resistance 1000 Ω min.)
- 4: 0 - 10 V DC (Load resistance 10 kΩ min.)
- 5: 0 - 5 V DC (Load resistance 5000 Ω min.)
- 6: 1 - 5 V DC (Load resistance 5000 Ω min.)
- 0: Specify voltage (See OUTPUT SPECIFICATIONS)

[6] POWER INPUT

AC Power

- M: 85 - 264 V AC (Operational voltage 85 - 264 V, 50/60 Hz
(CE marking not available))
- M2: 100 - 240 V AC (Operational voltage range 85 - 264 V, 50/60 Hz)

DC Power

- R: 24 V DC
(Operational voltage range 24 V ±15 %, ripple 10 %p-p max.)

[7] OPTIONS (multiple selections)

Standards & Approvals

- blank: Without CE
- /CE: CE marking

Bezels

blank: Bezels for M-System's 48 Series panel cutout
/D: Bezels for DIN panel cutout
/F: Bezels for Fuji Electric's PAJ, PAK, PBA panel cutout

Other Options

blank: none
/Q: Option other than the above (specify the specification)

SPECIFICATIONS OF OPTION: Q (multiple selections)

COATING (For the detail, refer to M-System's web site.)

Moving parts and indicators are not coated.

/C01: Silicone coating
/C02: Polyurethane coating
/C03: Rubber coating

EX-FACTORY SETTING

/SET: Preset according to the Ordering Information Sheet
 (No. ESU-9437)

BEZEL OPTION

Bezels are used to adapt the 48N Series to an existing panel cutout. In order to replace M-System's 48 Series products, use the one attached to the 48N Series as standard. When the existing panel is cut according to DIN standard, specify '/D' suffix code.

For a new installation, no bezel is required. Please refer to 'Mounting Requirement' and mount the 48N directly. Ingress protection is invalid when the 48N is mounted with a bezel, or when multiple modules are stacked side by side.

SPARE PARTS

- Scale plate

GENERAL SPECIFICATIONS

Construction: Panel flush mounting
Degree of protection: IP65; applicable to the front panel for single unit mounted according to the specified panel cutout
Connection: M3 separable screw terminal (torque 0.6 N·m)
Screw terminal: Nickel-plated steel
Housing material: Flame-resistant resin (black)
Isolation: Input to DC output to alarm output to power
Display zero adjustment: -10 to +10 %
DC output zero adjustment: -2 to +2 %
Display span adjustment: 90 to 110 %
DC output span adjustment: 98 to 102 %
Scale plate: Flame resistant resin (white scale & characters on black base)
Setpoint adjustment
2 points:
 H [L setpoint] to 100 %
 L 0 to [H setpoint]
 or No alarm trip

4 points:

HH [H setpoint] to 100 %
 H [L setpoint] to [HH setpoint]
 L [LL setpoint] to [H setpoint]
 LL 0 to [L setpoint]
 or No alarm trip

Alarm deadband (hysteresis): 1 %

Setting: (Front button)

- Zero and span adjustments
- Alarm setpoint
- Others

(Refer to the instruction manual for details)

Simulated output: Programmable within 0 - 100 %

■ BARGRAPH

LED: 101-segment LED, 100 mm (3.96") long, 3.00 mm (.12") wide

Display range: 0 to 100 (scaling function not available)

Scale: Two different scales available for single bargraph

Characters: Max. 4 characters including decimal point and negative sign

Divisions: Min. 22, max. 100

Engineering unit: Max. 6 characters

INPUT SPECIFICATIONS

■ **DC Current:** 0 - 50 mA DC; input resistor incorporated
Minimum span: 1 mA
 When specifying a resistance value, choose from below.
 5.1 Ω, 10 Ω, 12 Ω, 20 Ω, 39 Ω, 200 Ω
 ■ **DC Voltage:** -10 - +10 V DC
Input resistance: ≥ 1 MΩ
Minimum span: 0.1 V
Offset: Max. 1.5 times span

OUTPUT SPECIFICATIONS

■ **DC Current:** 0 - 20 mA DC
Minimum span: 1 mA
Offset: Max. 1.5 times span
Load resistance: Output drive 11 V max.
 ■ **DC Voltage:** -10 - +10 V DC
Minimum span: 1 V
Offset: Max. 1.5 times span
Load resistance: Output drive 1 mA max.; at ≥ 0.5 V
 ■ **Alarm Output:** Relay contact
Rated load: 250 V AC @1 A (cos φ = 1)
 30 V DC @5 A (resistive load)
Maximum switching voltage: 250 V AC, 220 V DC
Maximum switching power: 380 VA, 150 W
Minimum load: 5 V DC @100 mA
Mechanical life: ≥ 5 × 10⁸ cycles (rate 180 cycles/min.)

Alarm Trip Operation

Terminal No. in parentheses

• Alarm Output Code 2

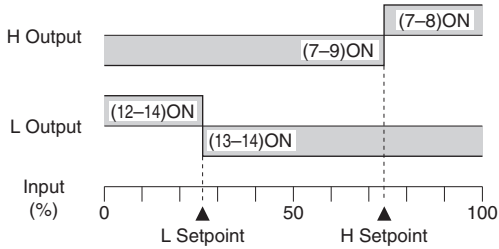

Terminals 7 – 9, 13 – 14 turn on at a loss of power.

• Alarm Output Code 4

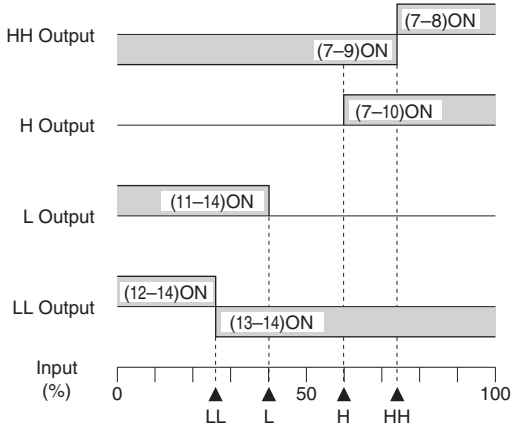

Terminals 7 – 9, 13 – 14 turn on at a loss of power.

≤ 1.0 sec. (0 – 90 %) (DC output)

Insulation resistance: ≥ 100 MΩ with 500 V DC

Dielectric strength: 2000 V AC @1 min. (input to DC output to alarm output to power to ground)

STANDARDS & APPROVALS

EU conformity:

EMC Directive

EMI EN 61000-6-4

EMS EN 61000-6-2

Low Voltage Directive

EN 61010-1

Measurement Category II

Pollution Degree 2

Input to alarm output to power:

Reinforced insulation (300 V)

DC output to power: Reinforced insulation (300 V)

RoHS Directive

EN 50581

INSTALLATION

Power Consumption

•AC:

Approx. 5.5 VA at 100 V with max. load

Approx. 7 VA at 200 V with max. load

Approx. 8 VA at 264 V with max. load

•DC

Approx. 3.5 W at 20.4 V with max. load

Approx. 3.5 W at 24 V with max. load

Approx. 3.5 W at 27.6 V with max. load

Operating temperature: -5 to +55°C (23 to 131°F)

Operating humidity: 30 to 90 %RH (non-condensing)

Mounting: Panel flush mounting

Weight: 300 g (0.66 lb)

PERFORMANCE in percentage of span

Accuracy:

±1 % ±1 digit (Display)

±0.1 % (DC output)

Temp. coefficient:

±0.015 % of FS/°C (±0.008 % of FS/°F) (Display)

±0.02 %/°C (±0.01 %/°F) (DC output)

Response time:

≤ 0.5 sec. (Display)

SCALE PLATE

■ WHAT MUST BE SPECIFIED WHEN ORDERING

Following two methods can specify scale plate.

a) Using 'Scale Plate Designer'

Access 'Design Scale Plate' in the M-System web site (<http://www.m-system.co.jp/english>). Scale plate can be designed in this web site.

By function below, it can be easy to create standard design or original design.

[Design Automatically]

Entering Minimum, Maximum, and Unit allows to create automatically a scale plate.

Maximum created scale division number is '54.9'. Use [Specify Division Number], if division number more than '54.9' is required (Maximum 100 division).

[Specify Division Interval]

Division Interval can be specified according to the application.

[Specify Division Number]

It is available to create originally with scale division number, length of line, position, character size, font and detailed position.

After designing is completed, register code is issued. Place the order with this code.

Once scale plate is designed, it is recorded. The register code can be used any number of times.

b) Specifying scale range and display unit when placing the order

It is available to create by specifying scale range and display unit for right and left.

Regarding design of scale plate such as division number, length of division number line, and character font, they are same as above [Design Automatically], M-System designs them.

■ DESIGNING BY 'DESIGN AUTOMATICALLY'

How 'Design Automatically' creates scale design is described succinctly below.

■ TYPES OF DIVISIONS

Five (5) types of divisions are used depending upon the scale span, which determined by the following equation:

$$\text{Scale Span} = (\text{Max. range value} - \text{Min. range value}) \times 10^n$$

where n = integer (used to limit the calculated scale span to the minimum of 1.1, below 11.0.)

The number of divisions is automatically determined by the scale span.

• Type 1: 1.1 Scale Span < 1.3

Number of divisions: 22 to 25.9

Scale: Starts at 0, increments by 0.02 / 0.2 / 2 / 20 / 200. Min. and max. values indicated. 4 digits including negative sign and decimal point.

Division lines: Long, Short, Medium, Short, Long (4 divisions repeated)

• Type 2: 1.3 Scale Span < 2.0

Number of divisions: 26 to 39.9

Scale: Starts at 0, increments by 0.03 / 0.3 / 3 / 30 / 300. Min. and max. values indicated. 4 digits including negative sign and decimal point.

Division lines: Long, Short, Medium, Short, Medium, Short, Long (6 divisions repeated)

Minimum Divisions	Maximum Divisions	Bipolar Scale
11	1.29	600
10	1.2	400
8	1.0	200
6	0.8	0
4	0.6	-200
2	0.4	-400
0	0.2	-600

Minimum Divisions	Maximum Divisions	Bipolar Scale
130	1.99	0.8
120	1.8	0.6
90	1.5	0.3
60	1.2	0
30	0.9	-0.3
0	0.6	-0.6
0	0.3	-0.8

• **Type 3: 2.0 Scale Span < 2.6**

Number of divisions: 40 to 51.9

Scale: Starts at 0, increments by 0.05 / 0.5 / 5 / 50 / 500. Min. and max. values indicated. 4 digits including negative sign and decimal point.

Division lines: Long, Short, Medium, Short, Medium, Short, Medium, Short, Medium, Short, Long (10 divisions repeated)

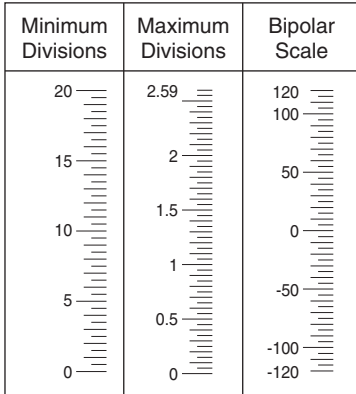

• **Type 5: 5.5 Scale Span < 11.0**

Number of divisions: 27.5 to 54.9

Scale: Starts at 0, increments by 0.01 / 0.1 / 1 / 10 / 100 / 1000. Min. and max. values indicated.

4 digits including negative sign and decimal point.

Division lines: Long, Medium, Medium, Medium, Medium, Long (5 divisions repeated)

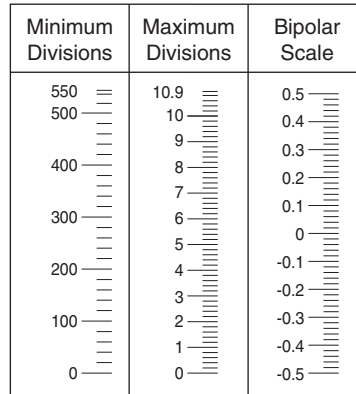

• **Type 4: 2.6 Scale Span < 5.5**

Number of divisions: 26 to 54.9

Scale: Starts at 0, increments by 0.05 / 0.5 / 5 / 50 / 500. Min. and max. values indicated. 4 digits including negative sign and decimal point.

Division lines: Long, Medium, Medium, Medium, Medium, Long (5 divisions repeated)

[Example] : Bargraph range 0 to 300 cm (Type 4)

Left scale range: 0 – 300

Left scale unit (bargraph): cm

Right scale: None

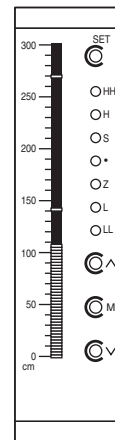
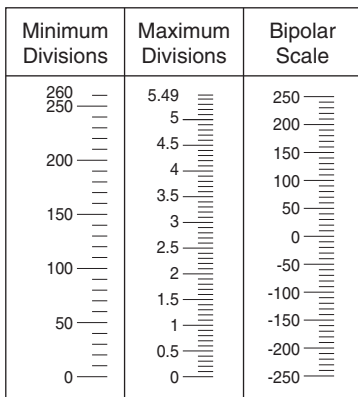

EXTERNAL VIEW

■ ALARM OUTPUT CODE 2: 2 points

• Vertical Mounting

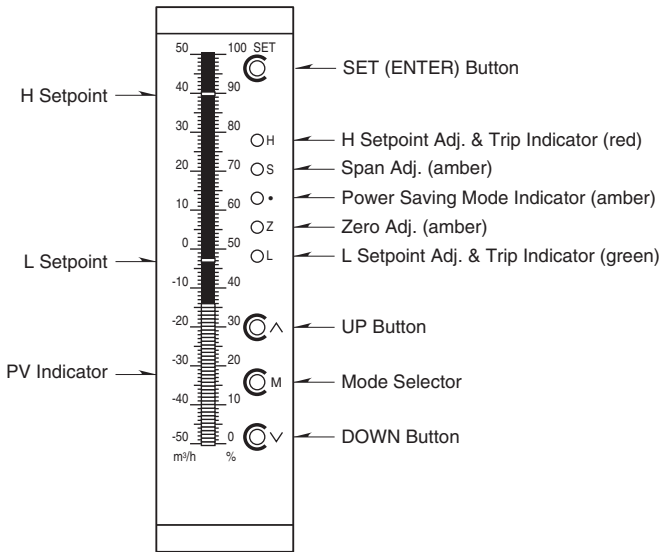

• Horizontal Mounting

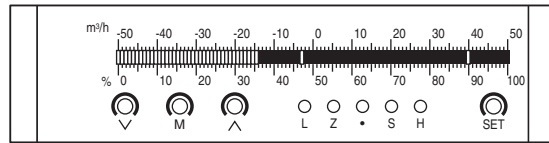

■ ALARM OUTPUT CODE 4: 4 points

• Vertical Mounting

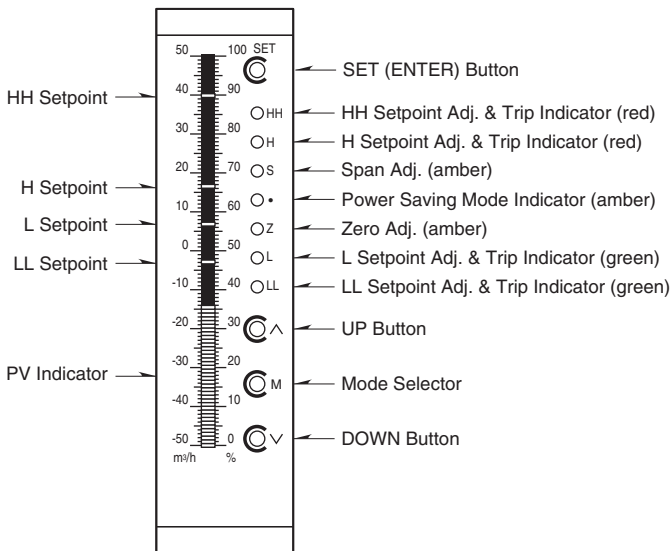

• Horizontal Mounting

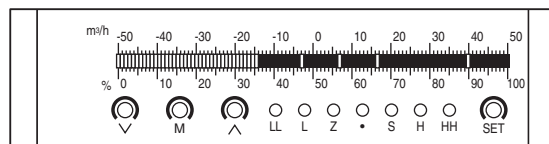

• Bar Color Patterns

Pattern 1 (model suffix code 1)

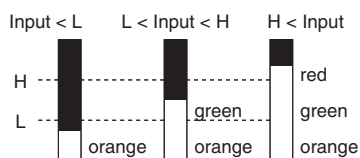

Pattern 2 (model suffix code 2)

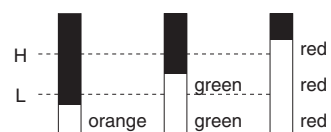

DIMENSIONS unit: mm (inch)

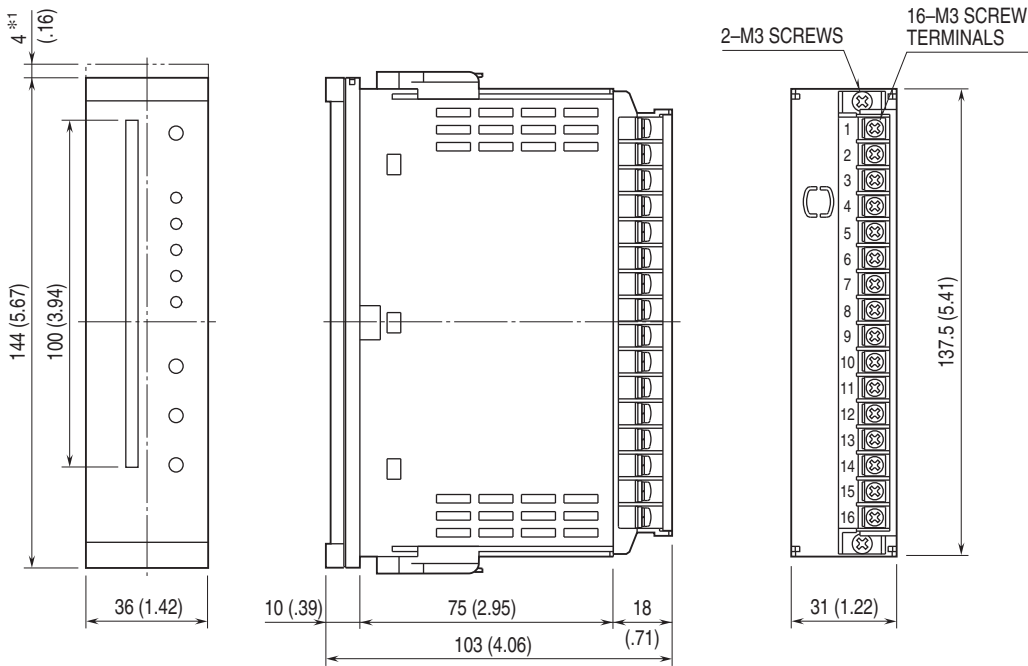

■ STANDARD BEZEL *2

■ OPTION /D BEZEL *3

■ OPTION /F BEZEL *4

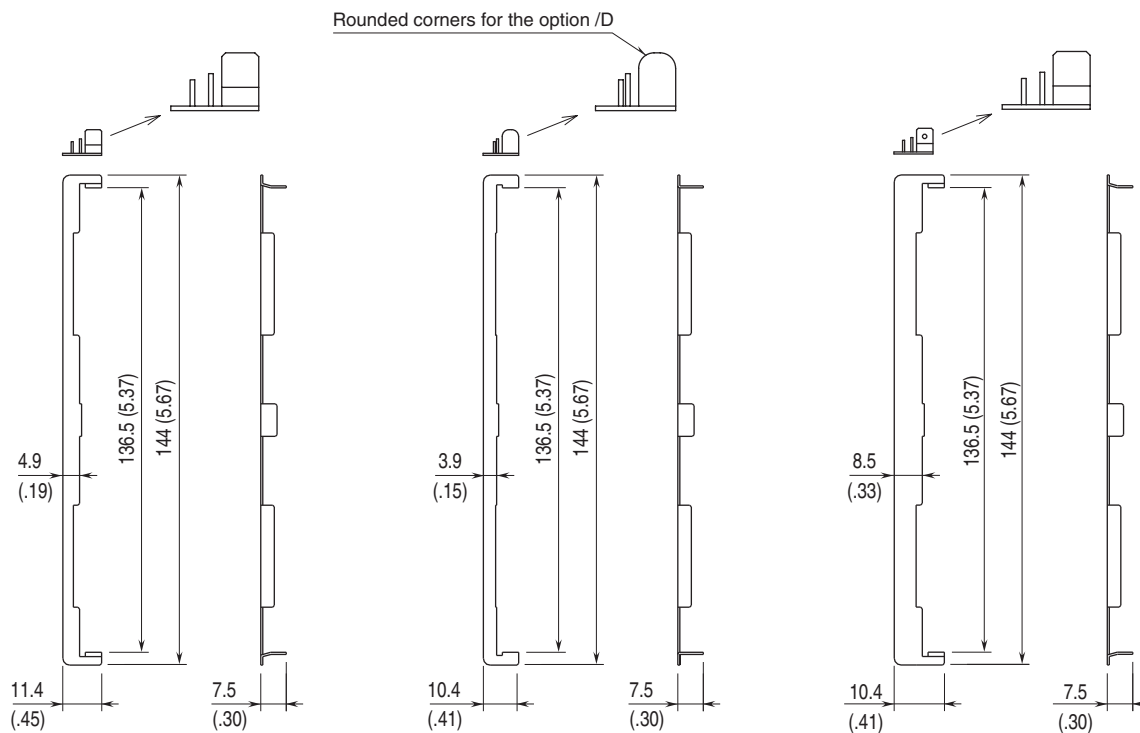

- *1. Space required when replacing the scale plate.
- *2. Used for the existing panel cutout of M-System 48 Series (38 × 139.5 mm).
- *3. Used for the existing DIN panel cutout (33 × 138 mm)
- *4. Used for the existing panel cutout of Fuji Electric PAJ, PAK, PBA (44 × 138 mm), etc.

PANEL CUTOUT unit: mm

■ SINGLE MOUNTING (ingress protection)

• Vertical Mounting

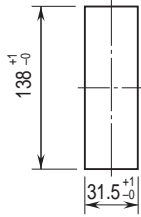

Panel thickness: 1.6 – 8.0 mm

• Horizontal Mounting

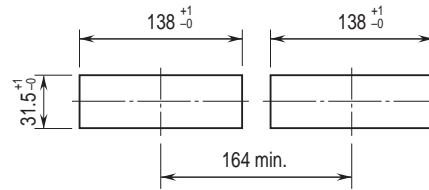

Panel thickness: 1.6 – 8.0 mm

■ CLUSTERED MOUNTING (no ingress protection)

• Vertical Mounting

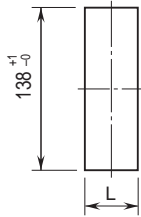

Panel thickness: 1.6 – 8.0 mm

$$L = \{31.5 + 36 \times (N - 1)\}^{+1}_{-0}$$

(N : number of units)

• Horizontal Mounting

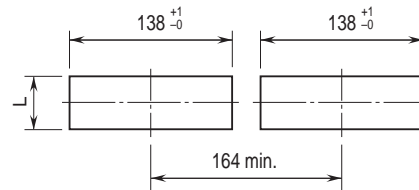

Panel thickness: 1.6 – 8.0 mm

$$L = \{31.5 + 36 \times (N - 1)\}^{+1}_{-0}$$

(N : number of units)

Note 1. Observe at the minimum of 3 cm above and below the units for heat dissipation.
 Note 2. No bezel is needed when the panel is cut according to the above drawings.

SCHEMATIC CIRCUITRY & CONNECTION DIAGRAM

■ ALARM OUTPUT CODE 2: 2 points

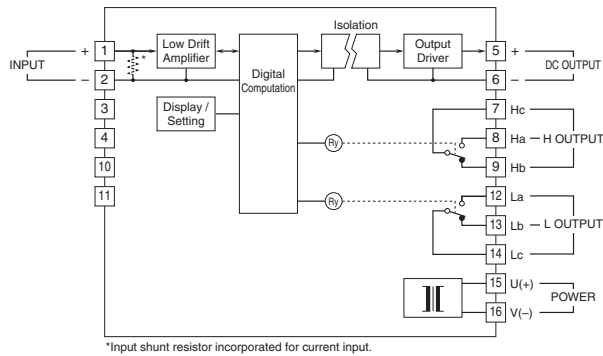

■ ALARM OUTPUT CODE 4: 4 points

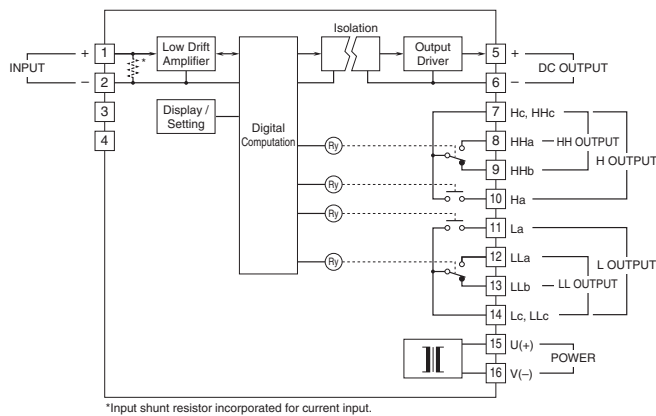

■ Relay Protection

• AC Powered

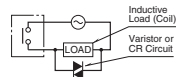

• DC Powered

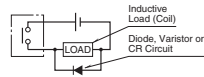



Specifications are subject to change without notice.